

EXPLODED DRAWING A—Model No. PFEL57907.1

R0808A

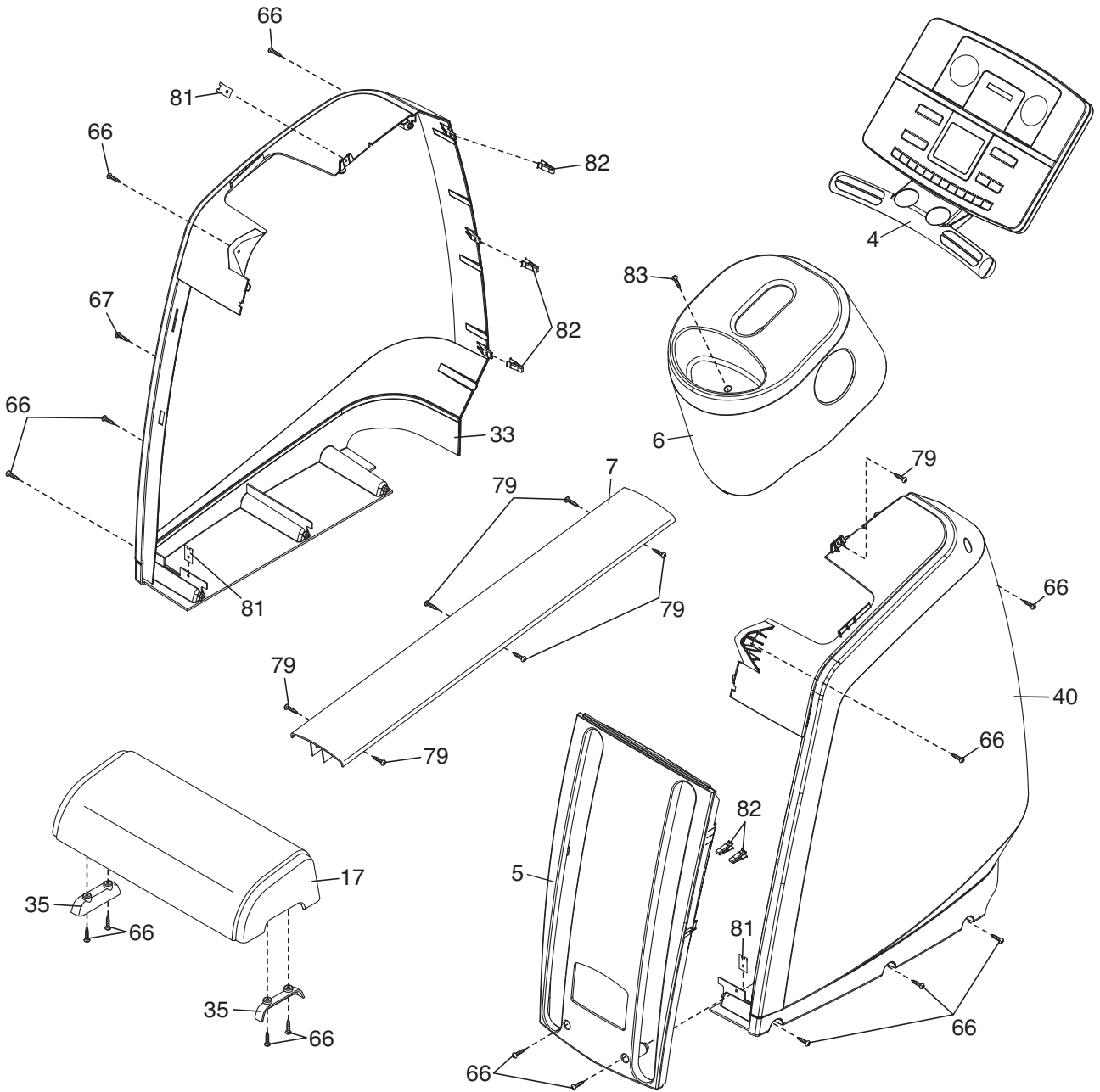

EXPLODED DRAWING B—Model No. PFEL57907.1

R0808A

23

