

EXPLODED DRAWING A—Model No. PFEL57908.1

R0509A

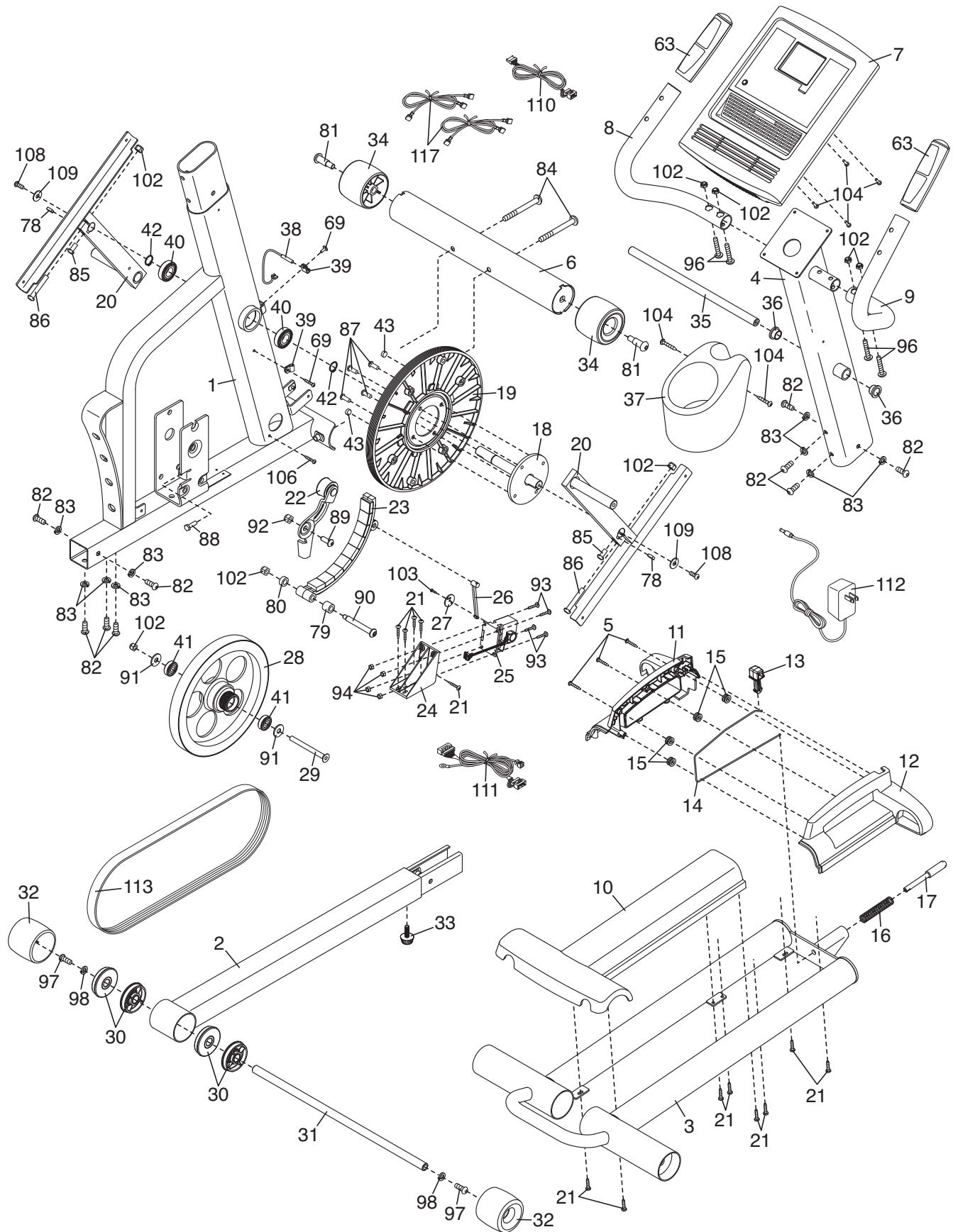

EXPLODED DRAWING B—Model No. PFEL57908.1

R0509A

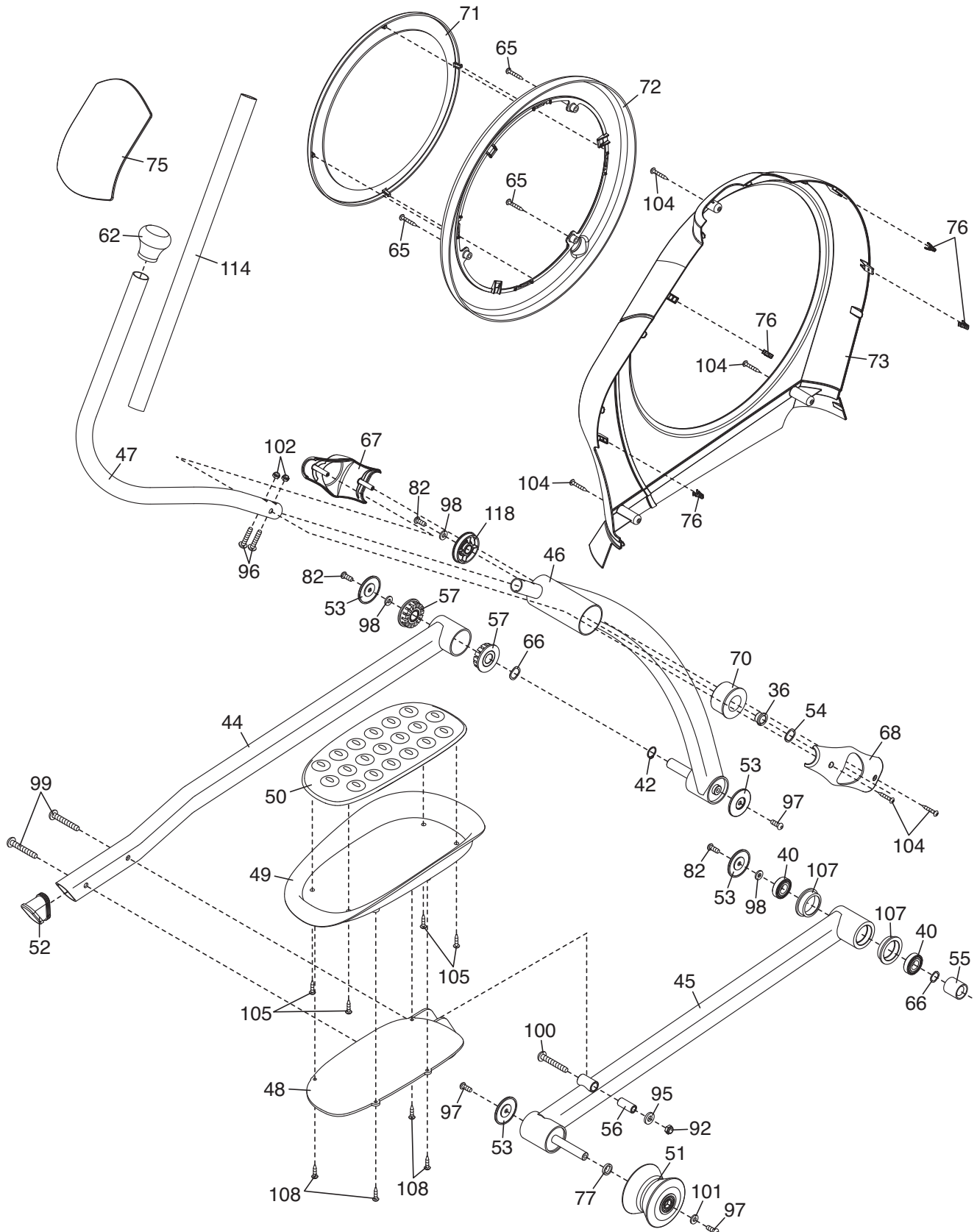

EXPLODED DRAWING C—Model No. PFEL57908.1

R0509A

