

# EXPLODED DRAWING A—Model No. PFEL57908.2

R0210A

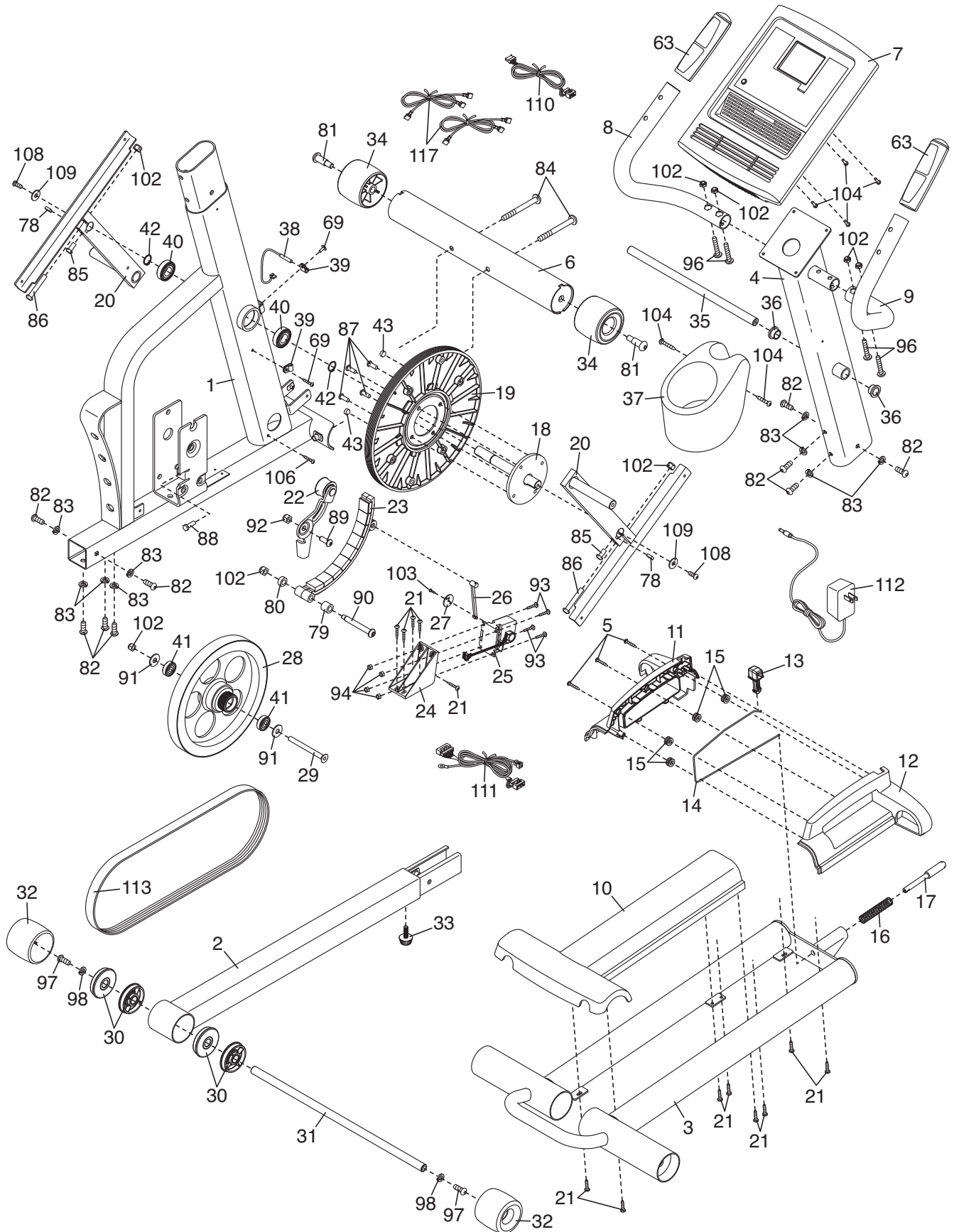

# EXPLODED DRAWING B—Model No. PFEL57908.2

R0210A

