

EXPLODED DRAWING A

Model No. PFEL57914.3 R1015A

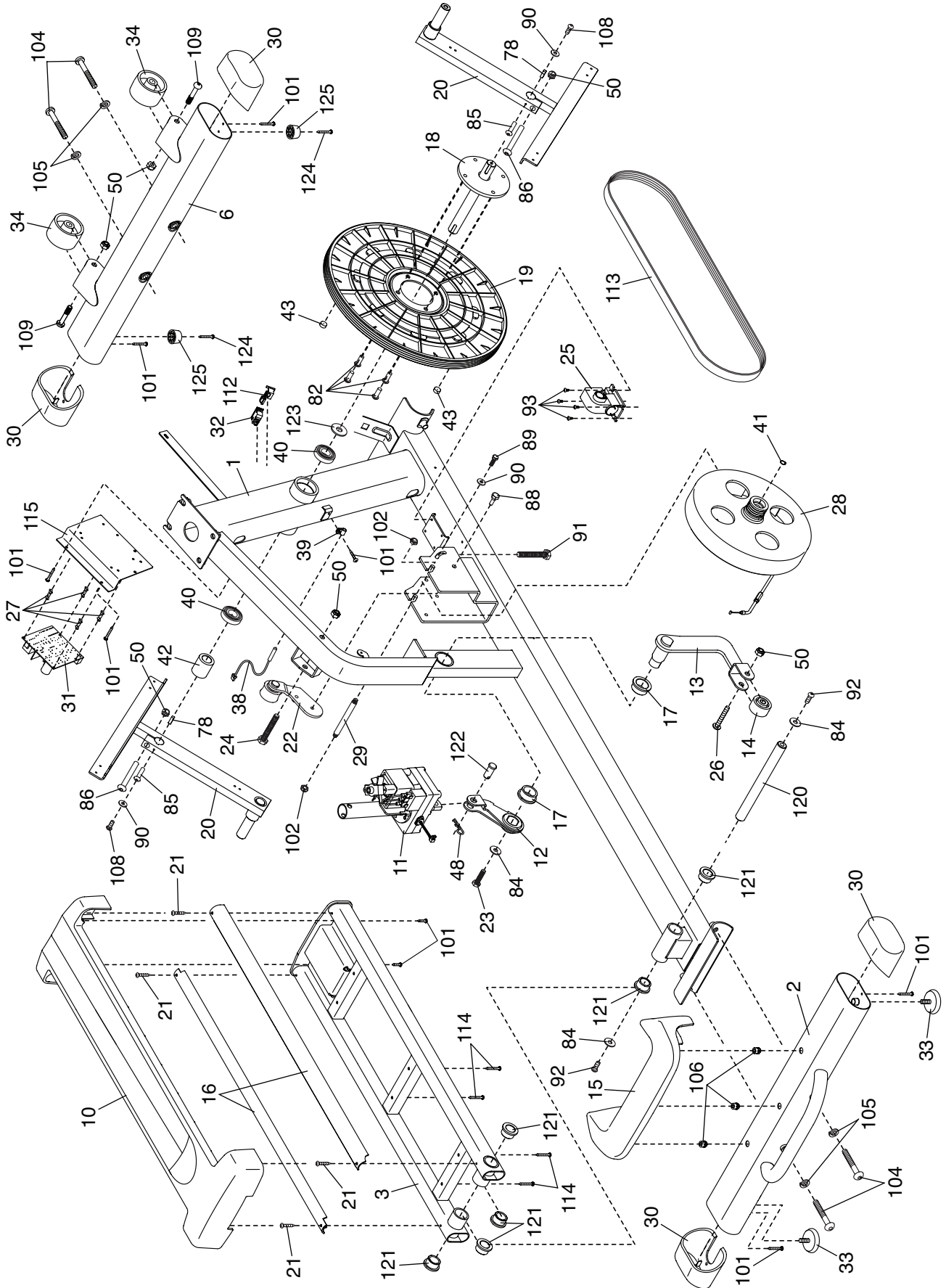

EXPLODED DRAWING B

Model No. PFEL57914.3 R1015A

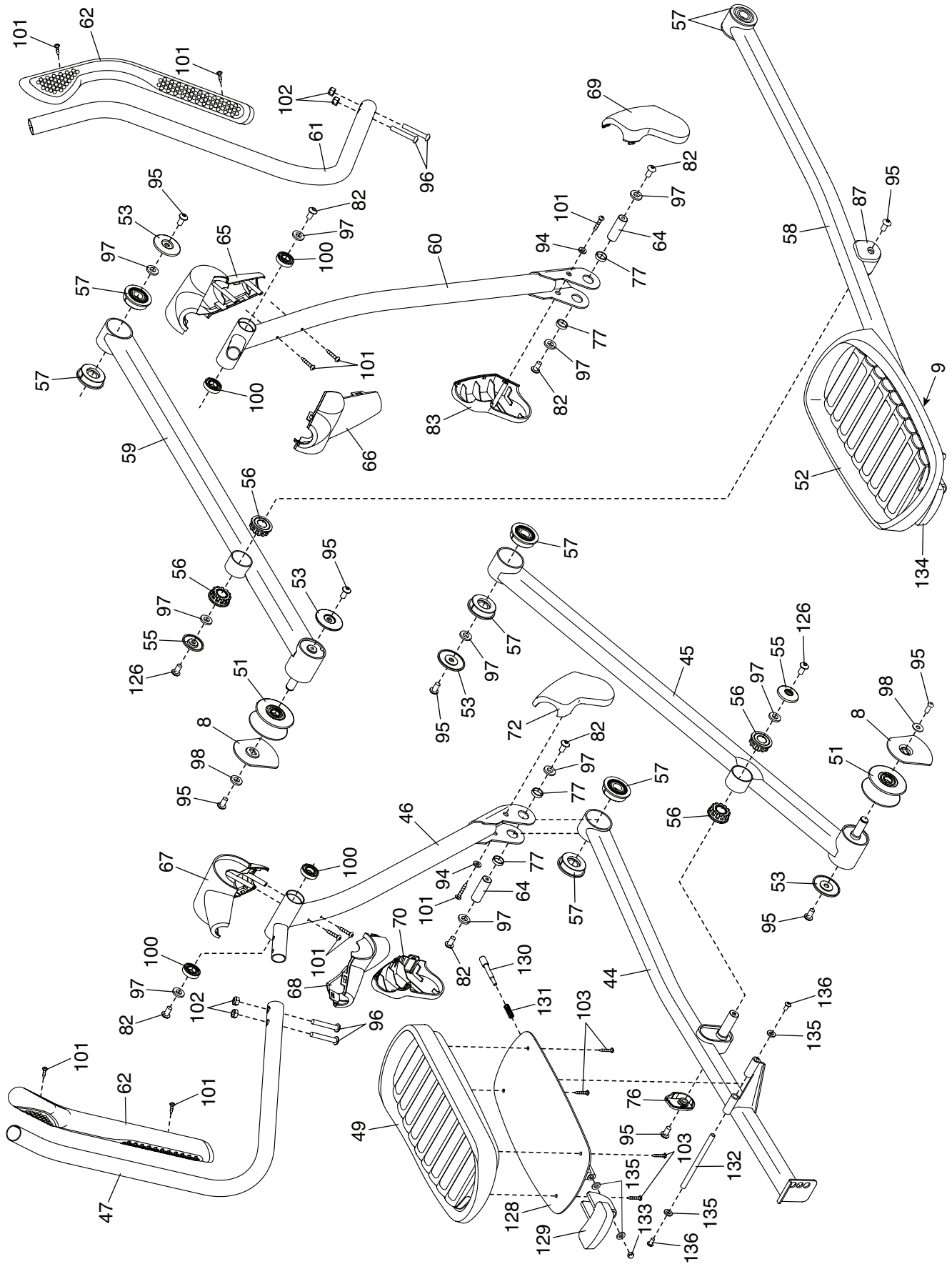

EXPLODED DRAWING C

Model No. PFEL57914.3 R1015A

