

# EXPLODED DRAWING A

Model No. PFEL57914.4 R1016A

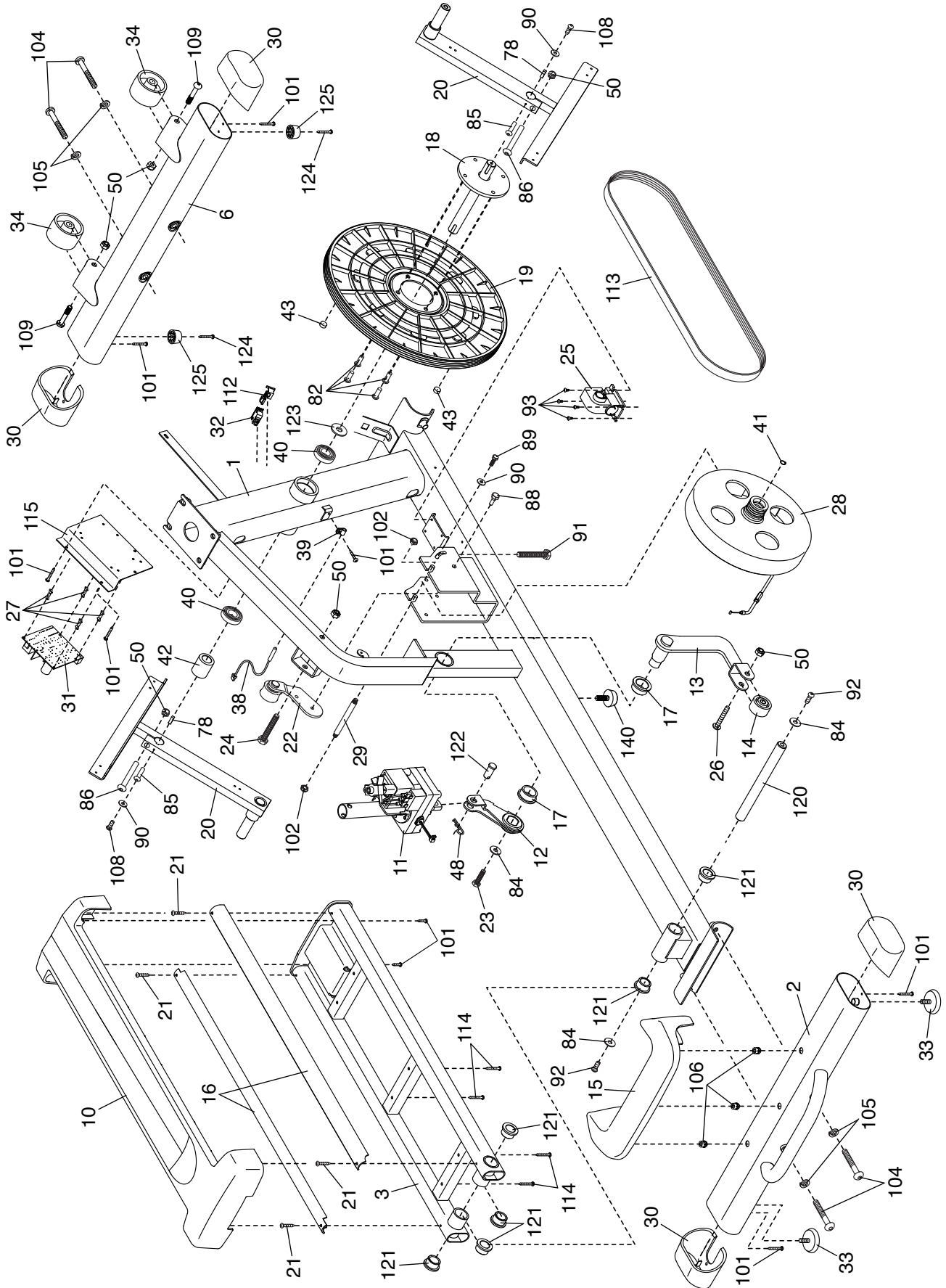



# EXPLODED DRAWING C

Model No. PFEL57914.4 R1016A

