

# EXPLODED DRAWING A

Model No. PFEL58015.0 R1214A

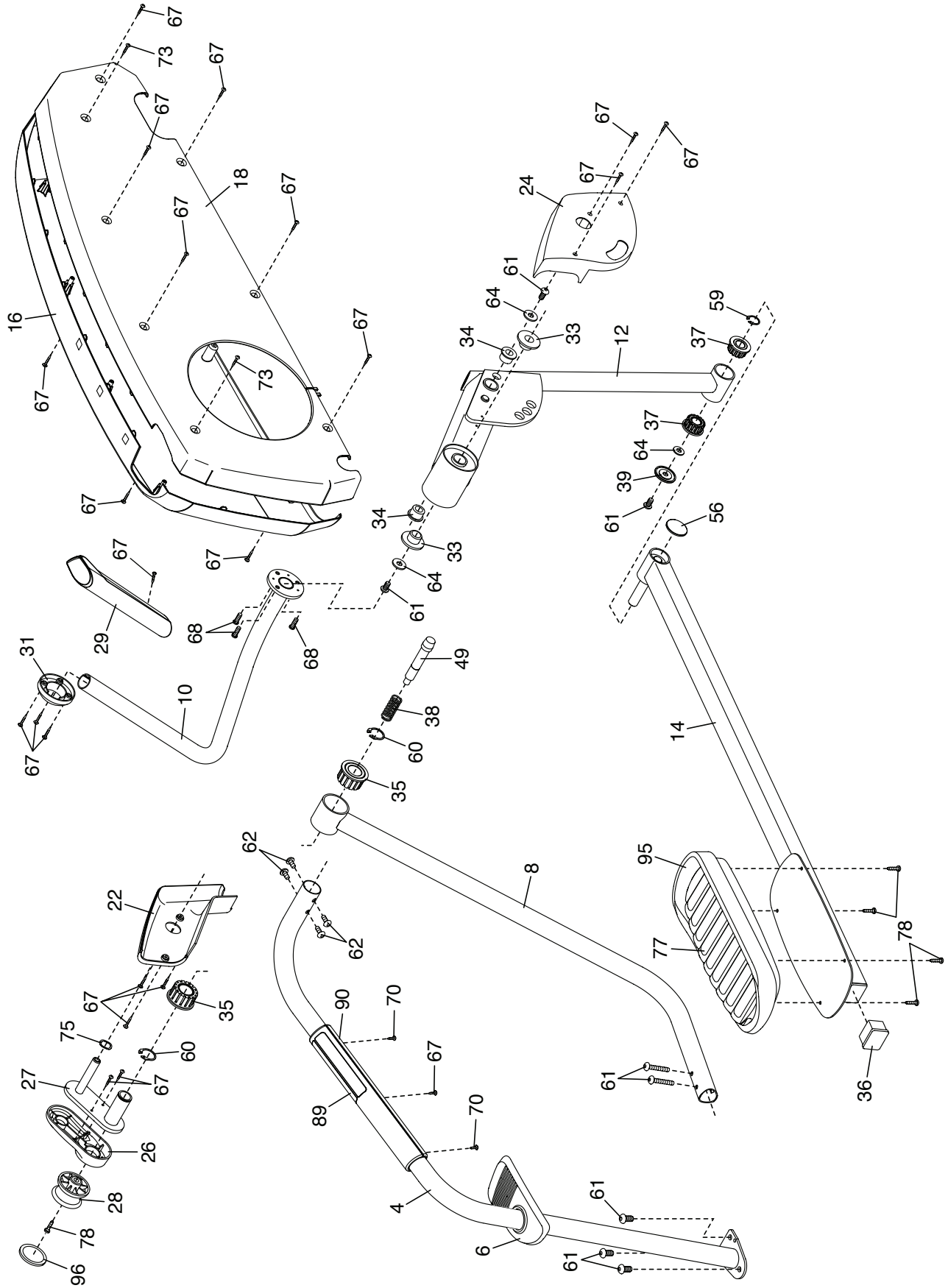

# EXPLODED DRAWING B

Model No. PFEL58015.0 R1214A

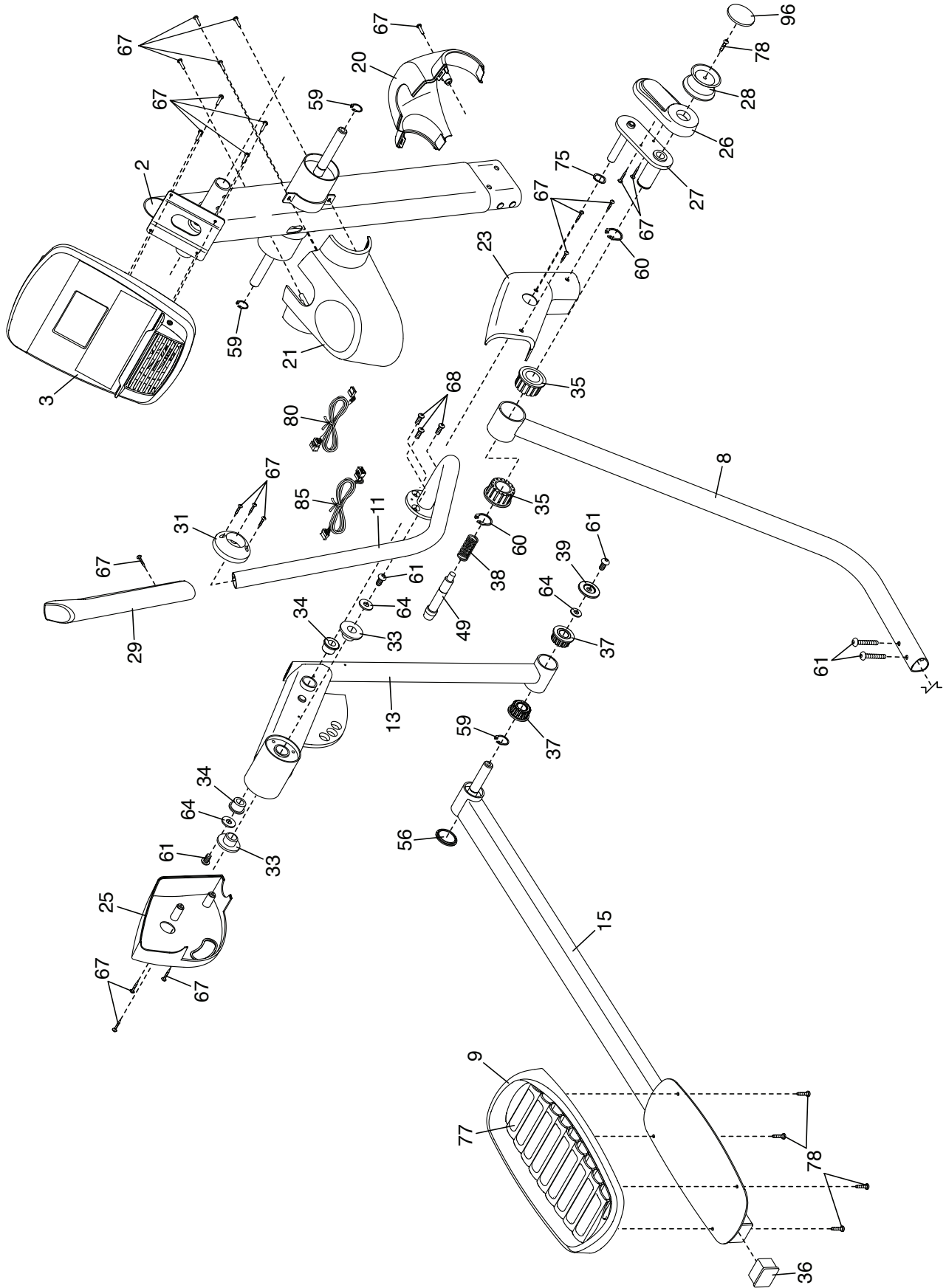

# EXPLODED DRAWING C

Model No. PFEL58015.0 R1214A

