

# EXPLODED DRAWING A

Model No. PFEL59718.2 R1019A

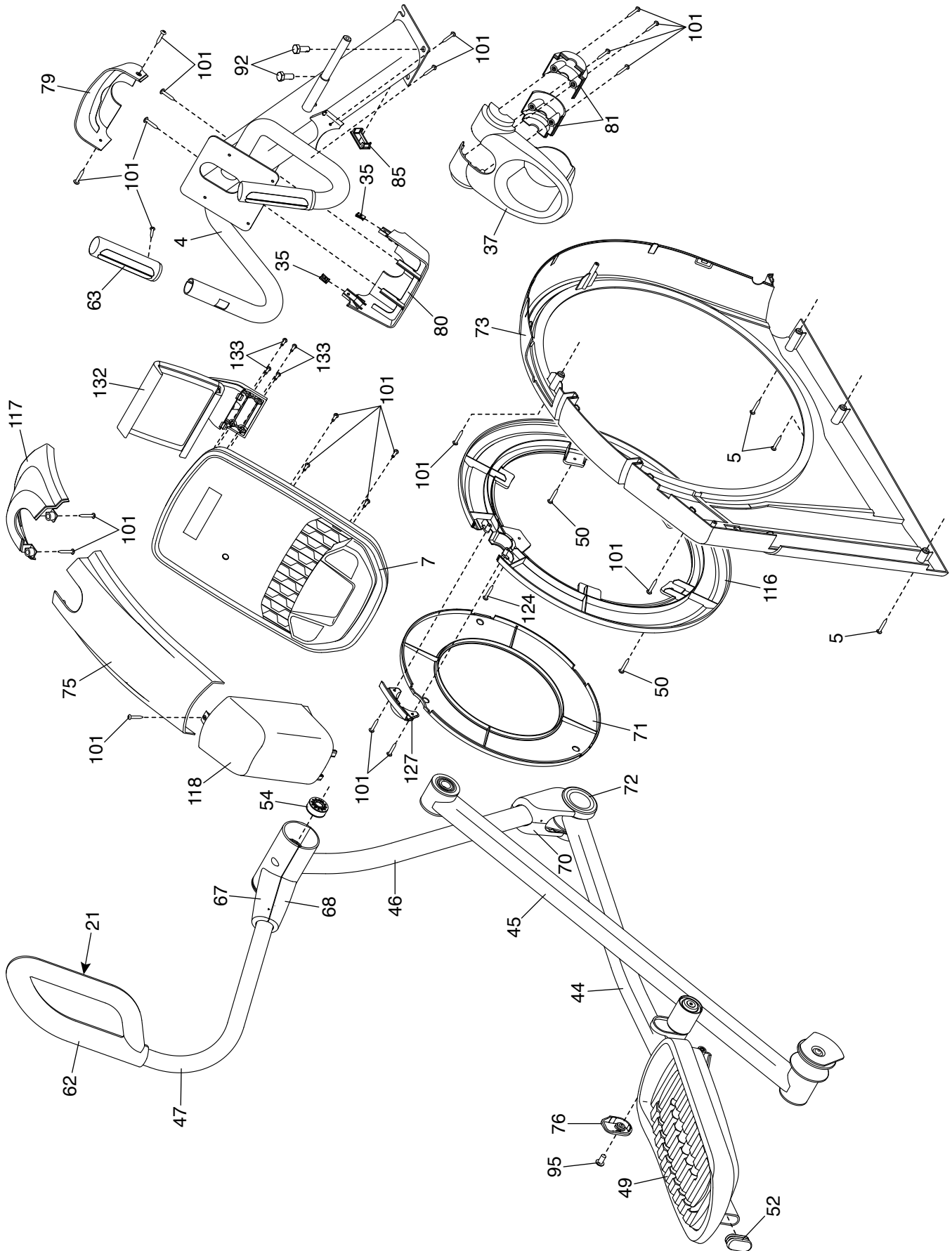

# EXPLODED DRAWING B

Model No. PFEL59718.2 R1019A

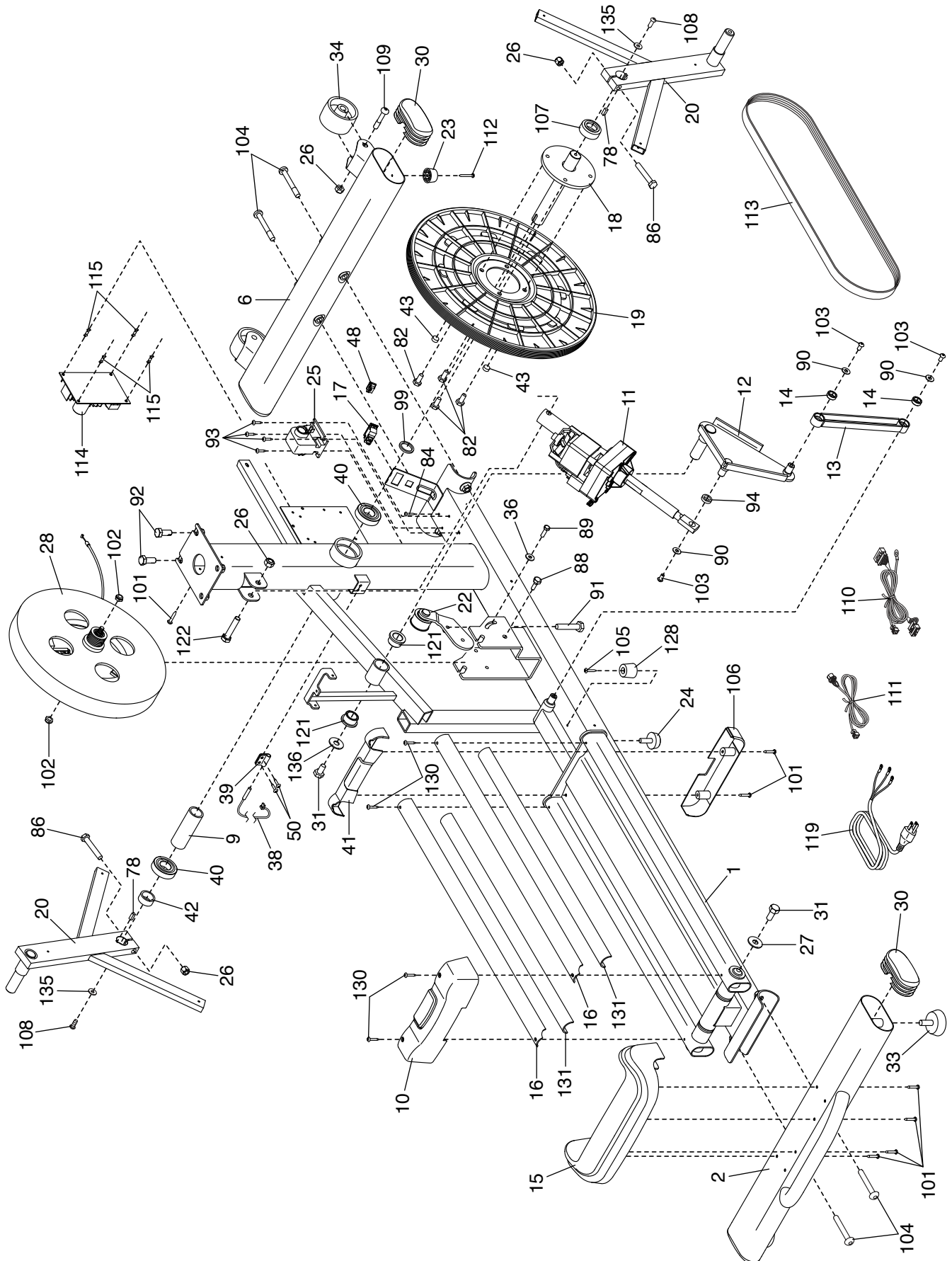

# EXPLODED DRAWING C

Model No. PFEL59718.2 R1019A

