

EXPLODED DRAWING A

Model No. PFEL59914.1 R1016A

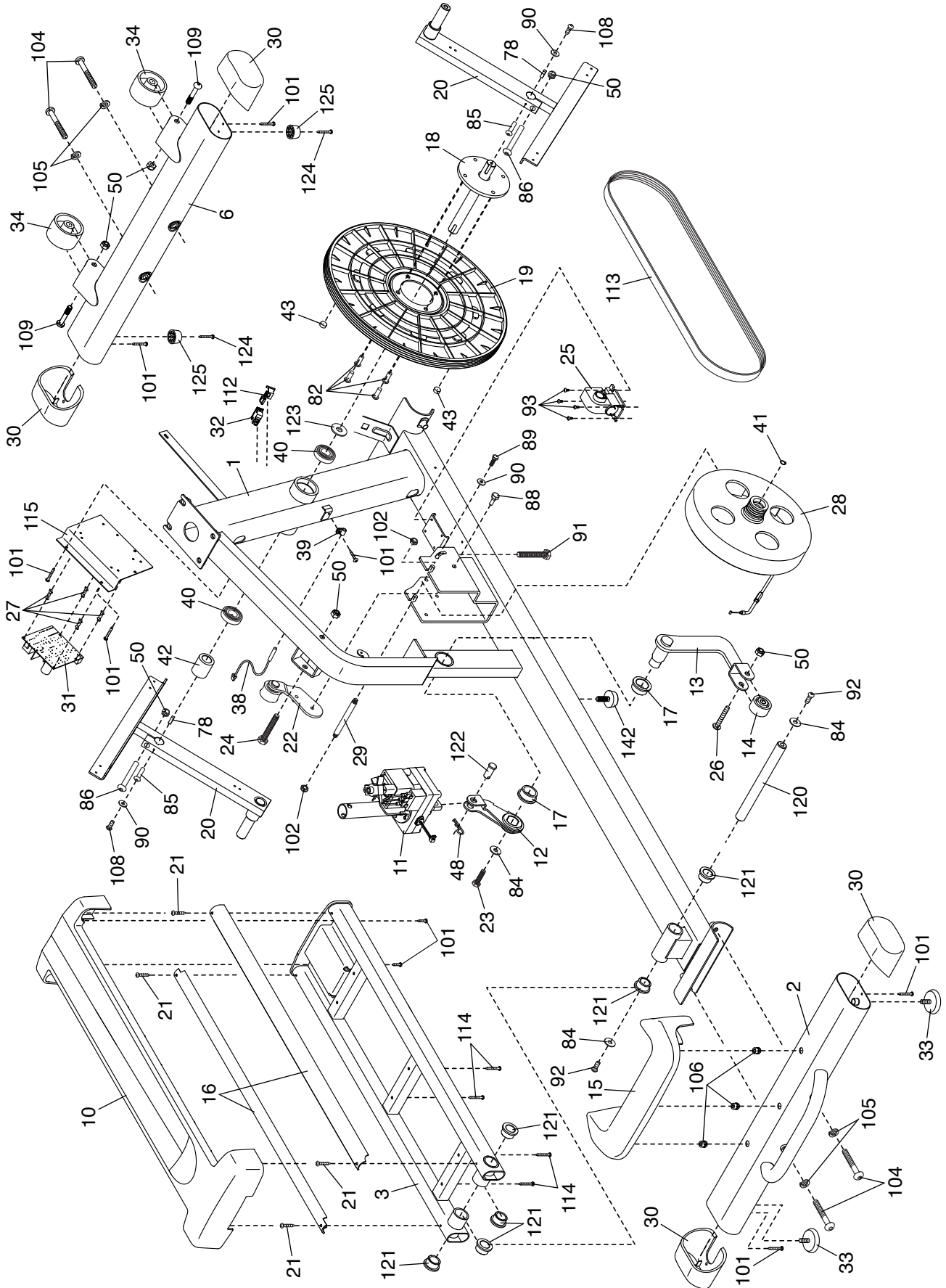

EXPLODED DRAWING B

Model No. PFEL59914.1 R1016A

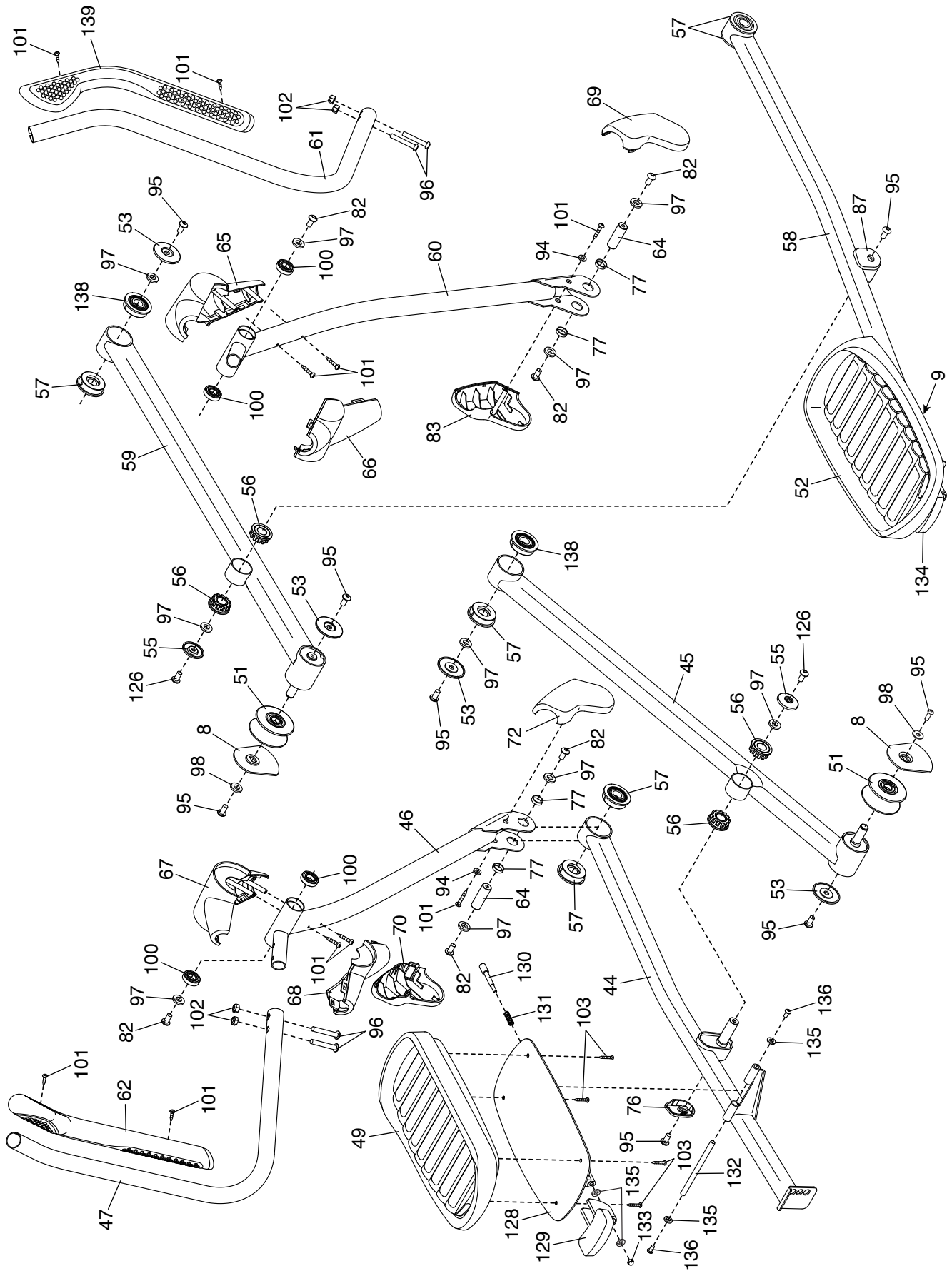

EXPLODED DRAWING C

Model No. PFEL59914.1 R1016A

