

# EXPLODED DRAWING A

Model No. PFEL59914.0 R1115A

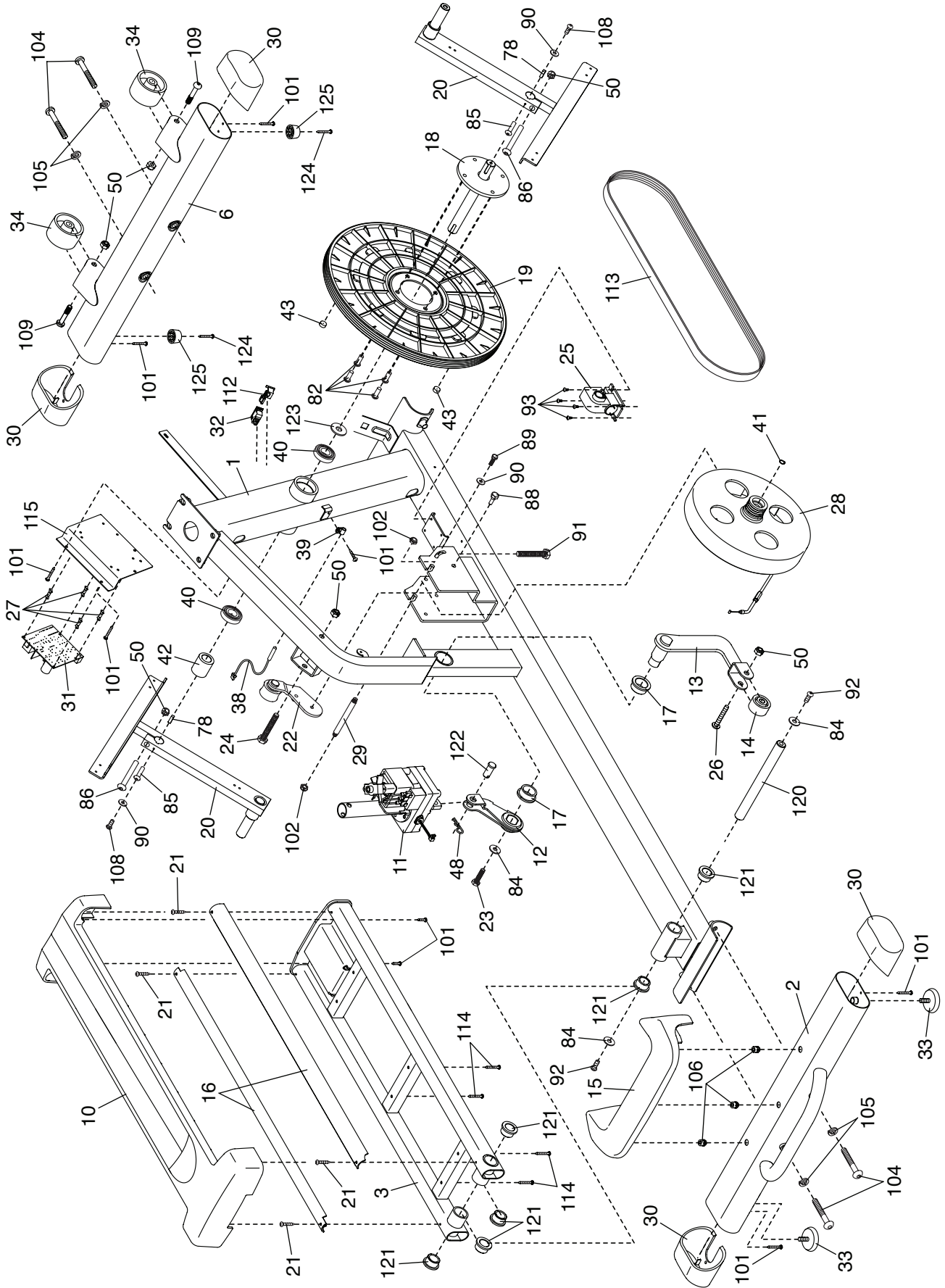

# EXPLODED DRAWING B

Model No. PFEL59914.0 R1115A

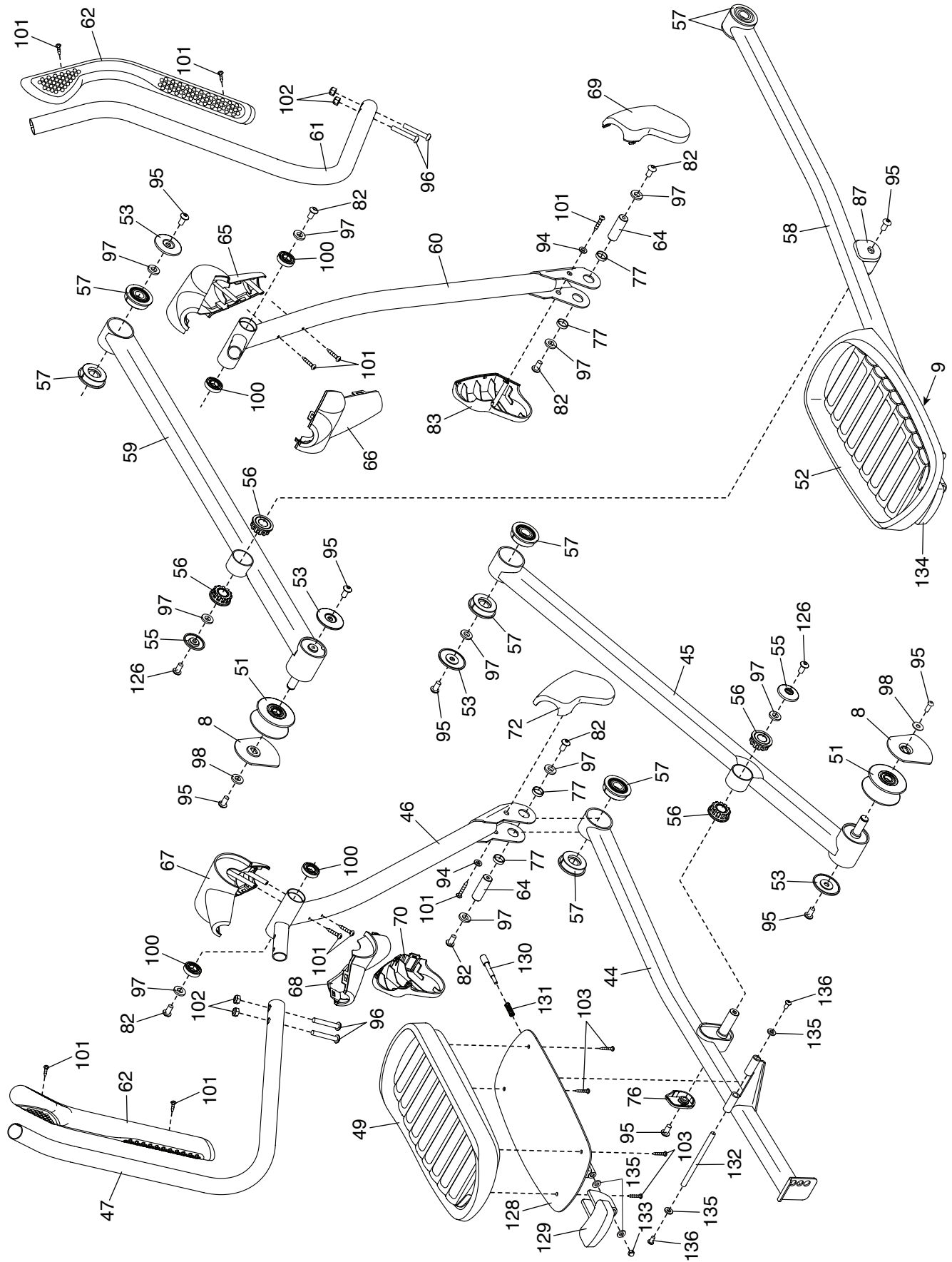

# EXPLODED DRAWING C

Model No. PFEL59914.0 R1115A

