

EXPLODED DRAWING A

Model No. PFEL62919.1 R0919A

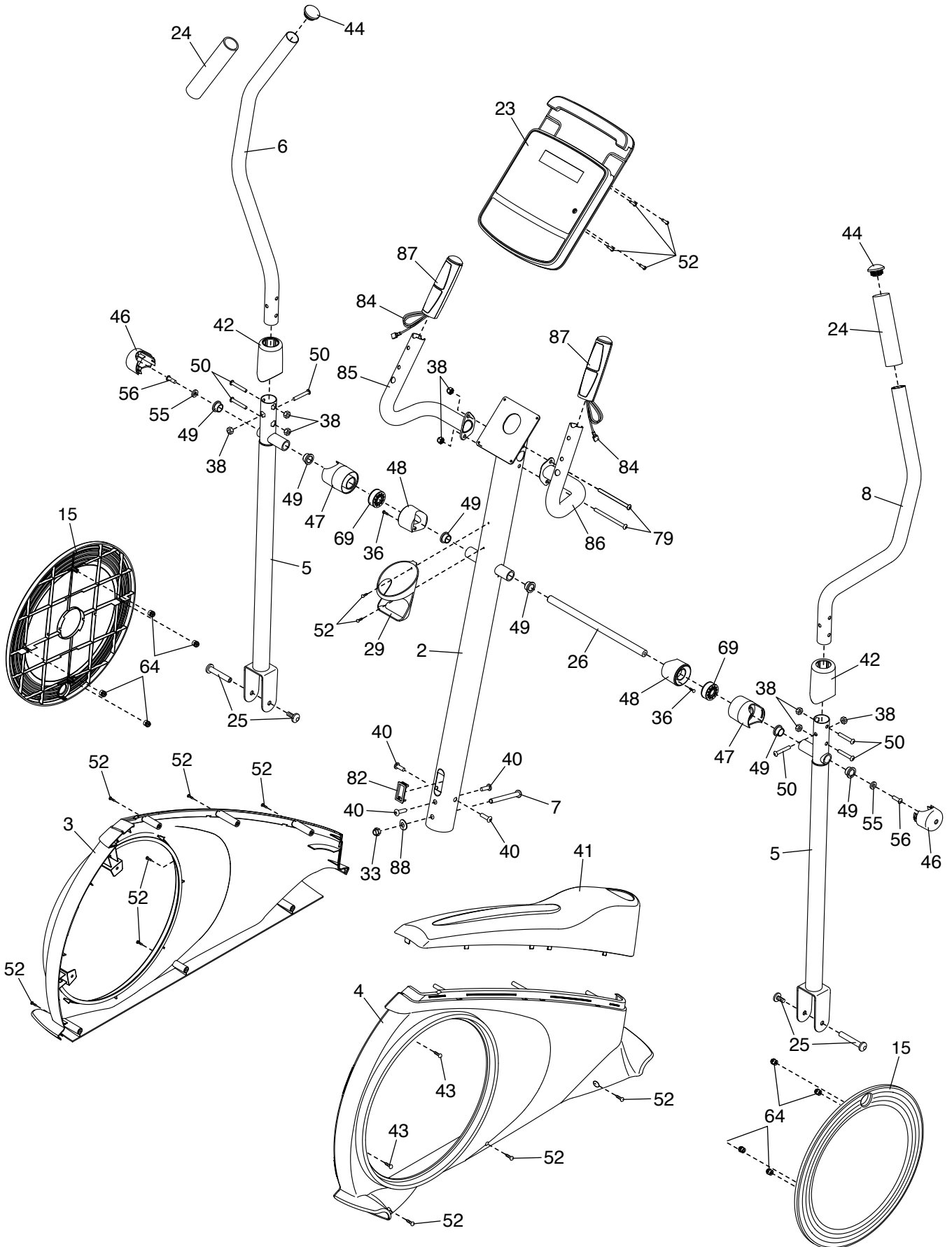

EXPLODED DRAWING B

Model No. PFEL62919.1 R0919A

