

EXPLODED DRAWING A—Model No. PFEL77908.0

R0508A

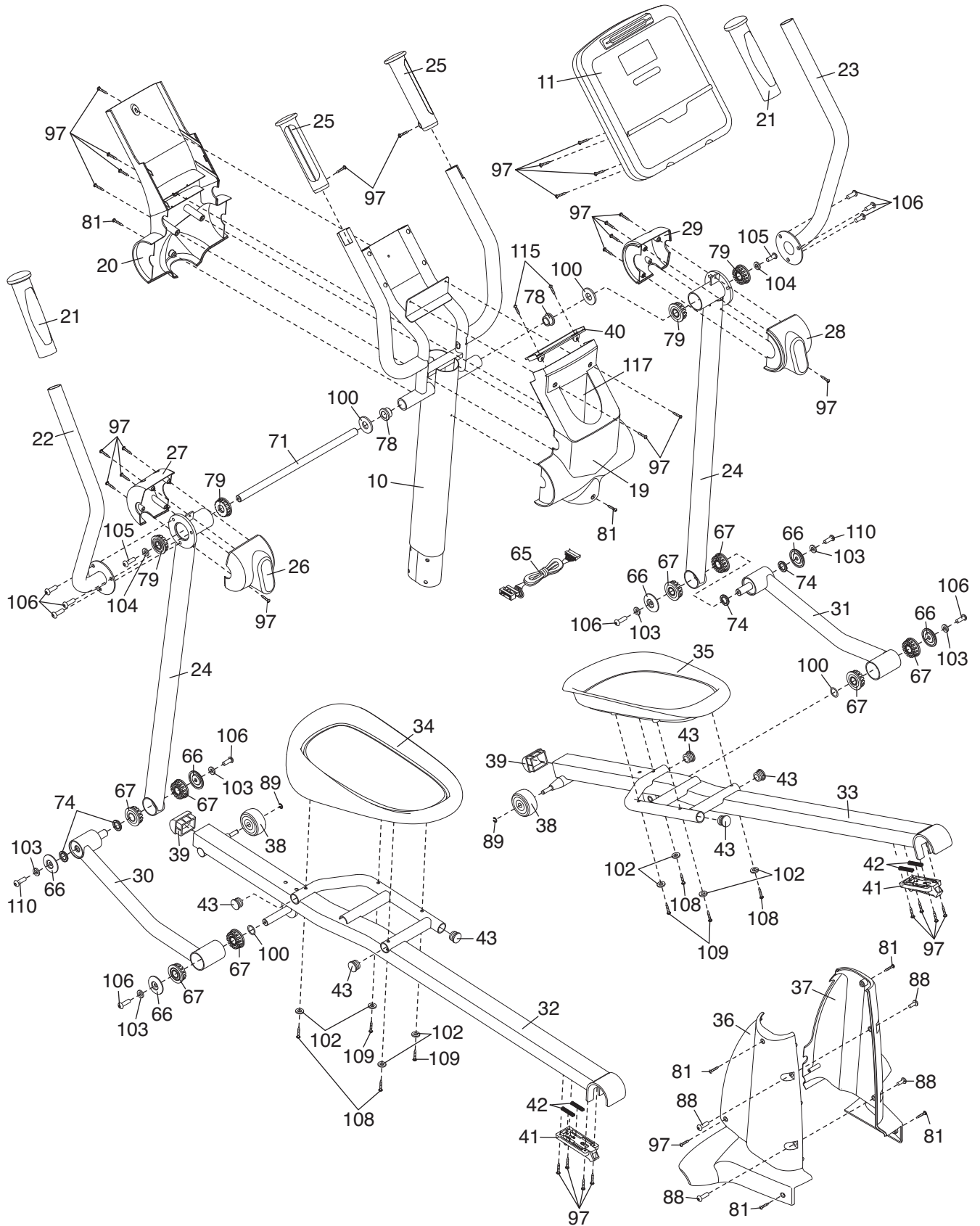

EXPLODED DRAWING B—Model No. PFEL77908.0

R0508A

