

EXPLODED DRAWING A—Model No. PFEL77908.2

R0308A

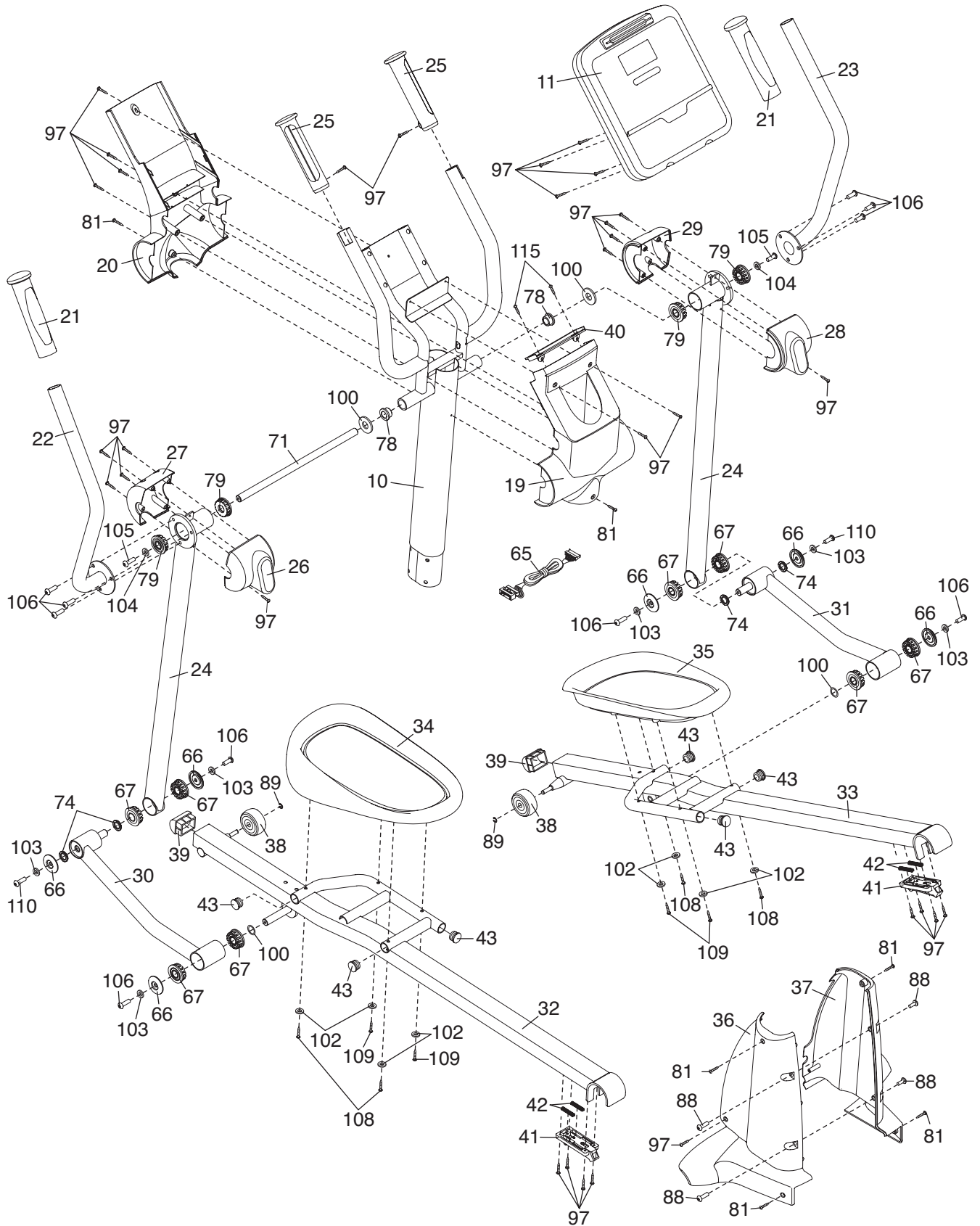

EXPLODED DRAWING B—Model No. PFEL77908.2

R0308A

