

EXPLODED DRAWING A—Model No. PFEL77908.3

R0608A

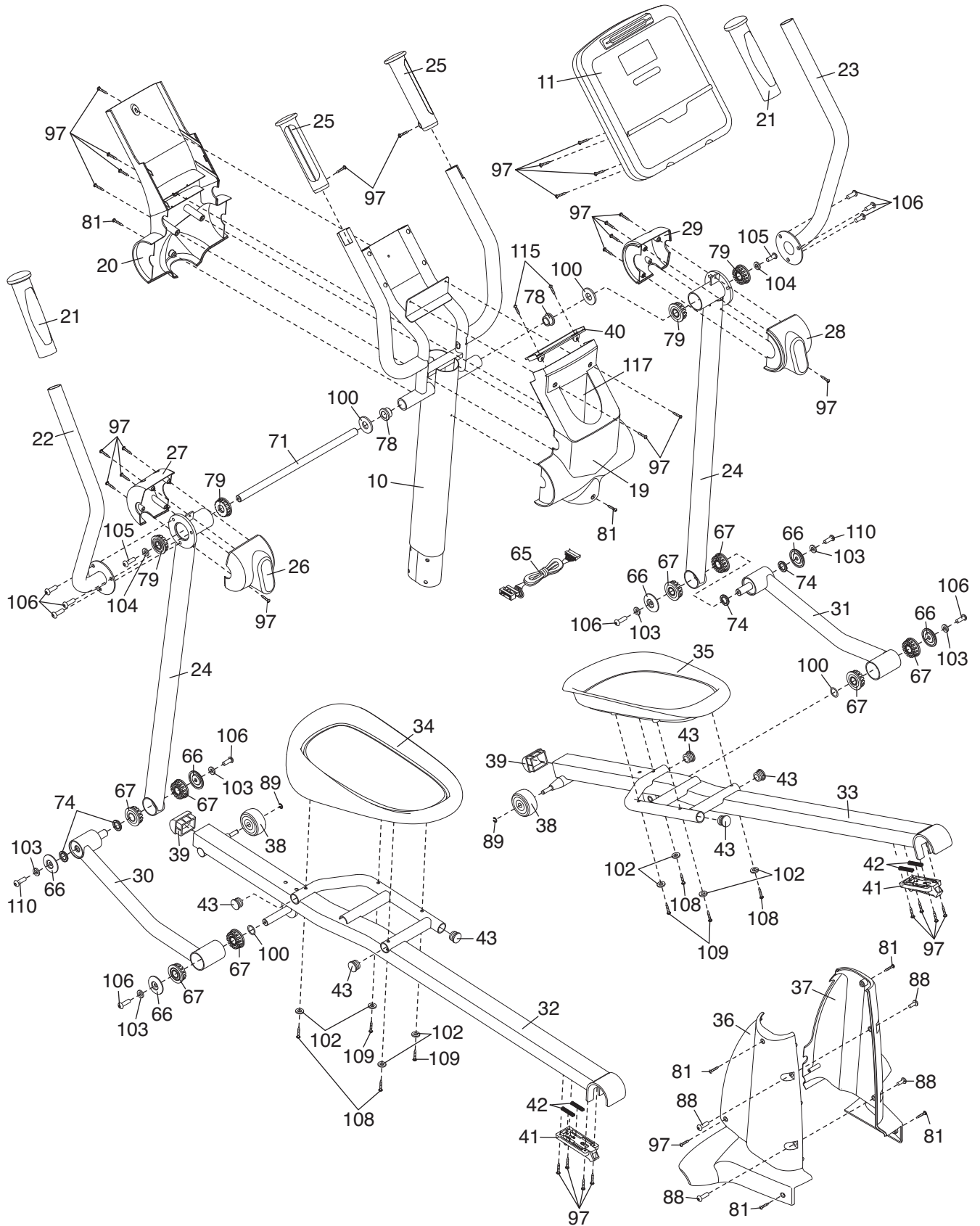

EXPLODED DRAWING B—Model No. PFEL77908.3

R0608A

