

EXPLODED DRAWING A—Model No. PFEL85607.0

R1107A

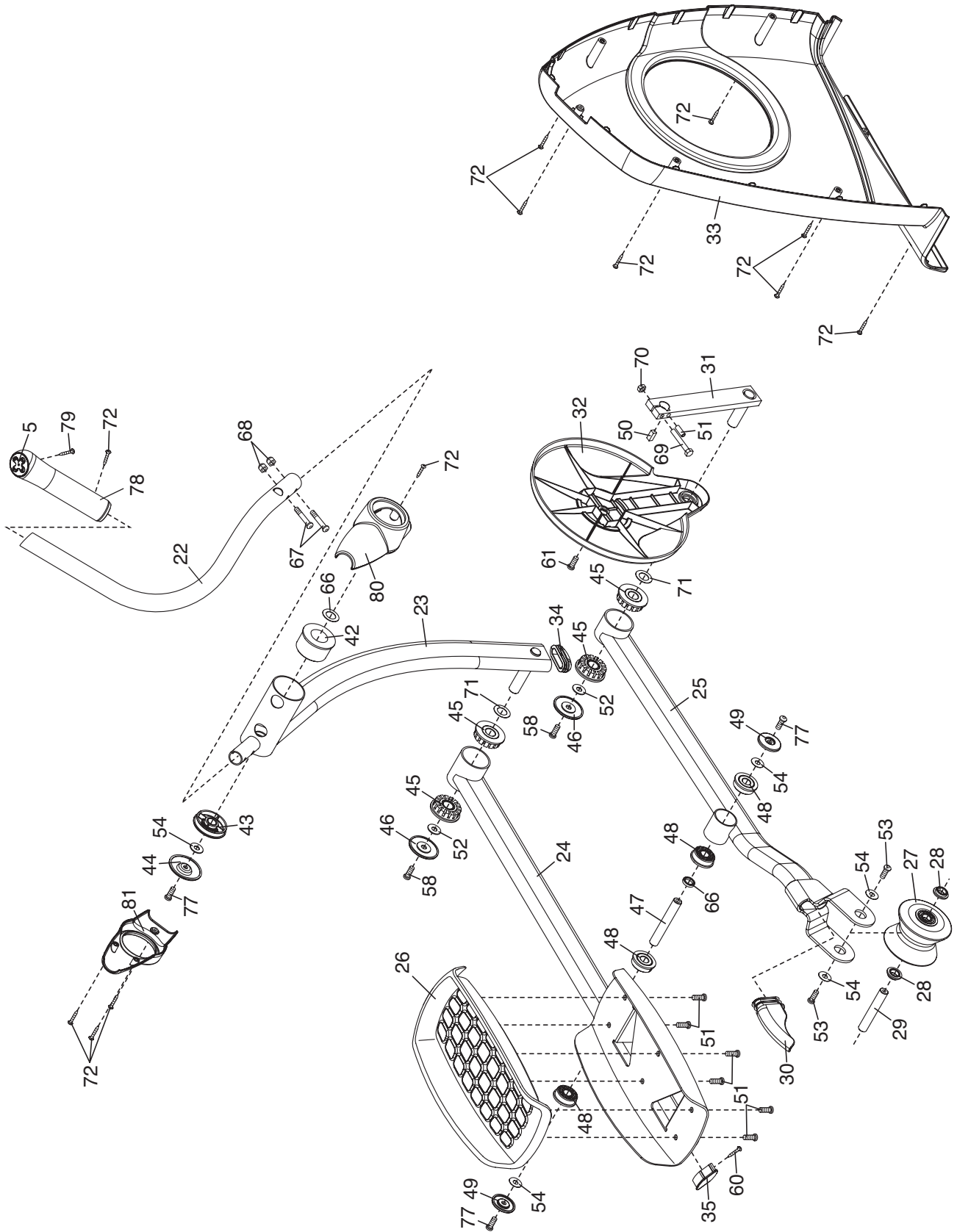

EXPLODED DRAWING B—Model No. PFEL85607.0

R1107A

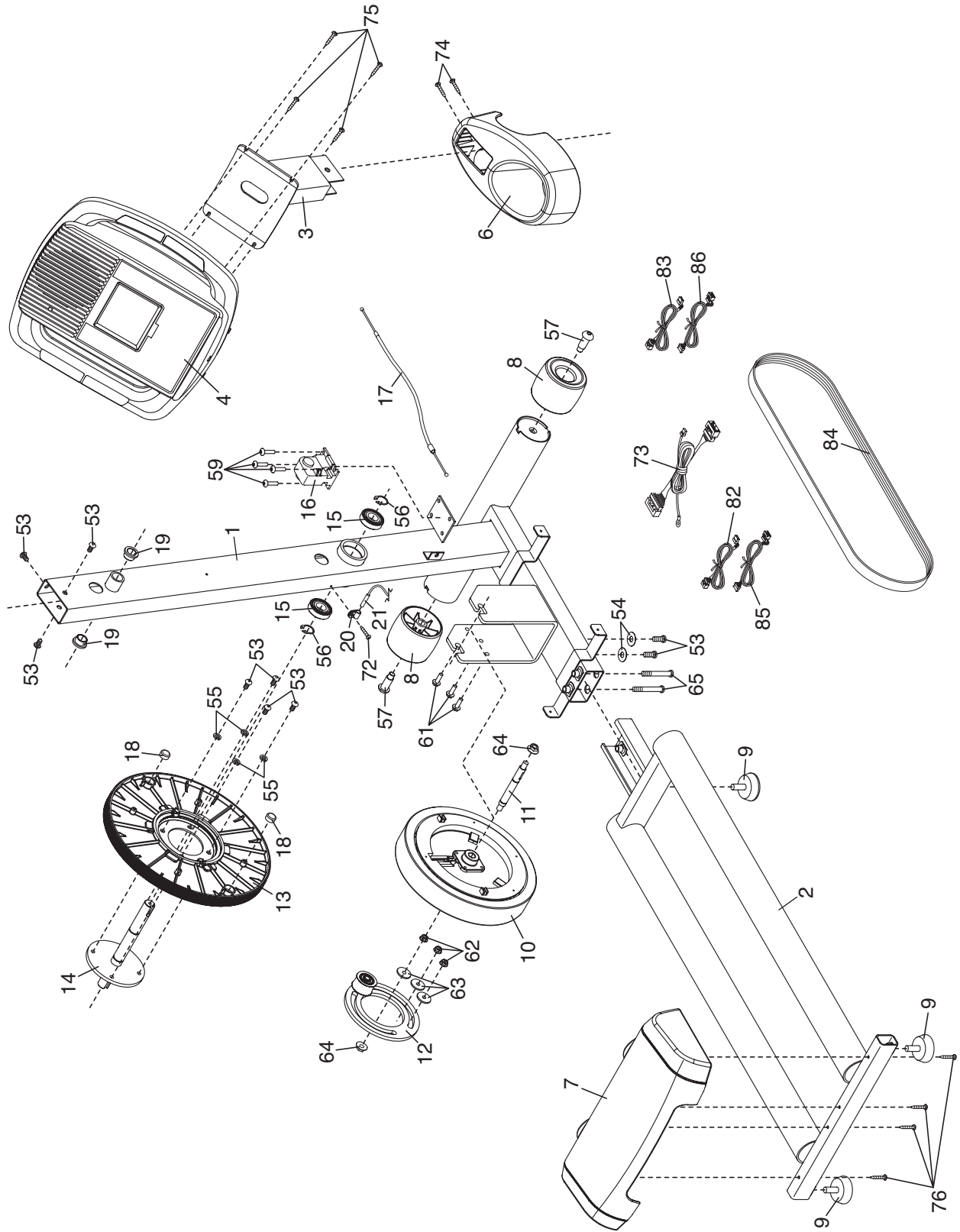

EXPLODED DRAWING C—Model No. PFEL85607.0

R1107A

