

EXPLODED DRAWING A—Model No. PFEL95918.0

R0808A

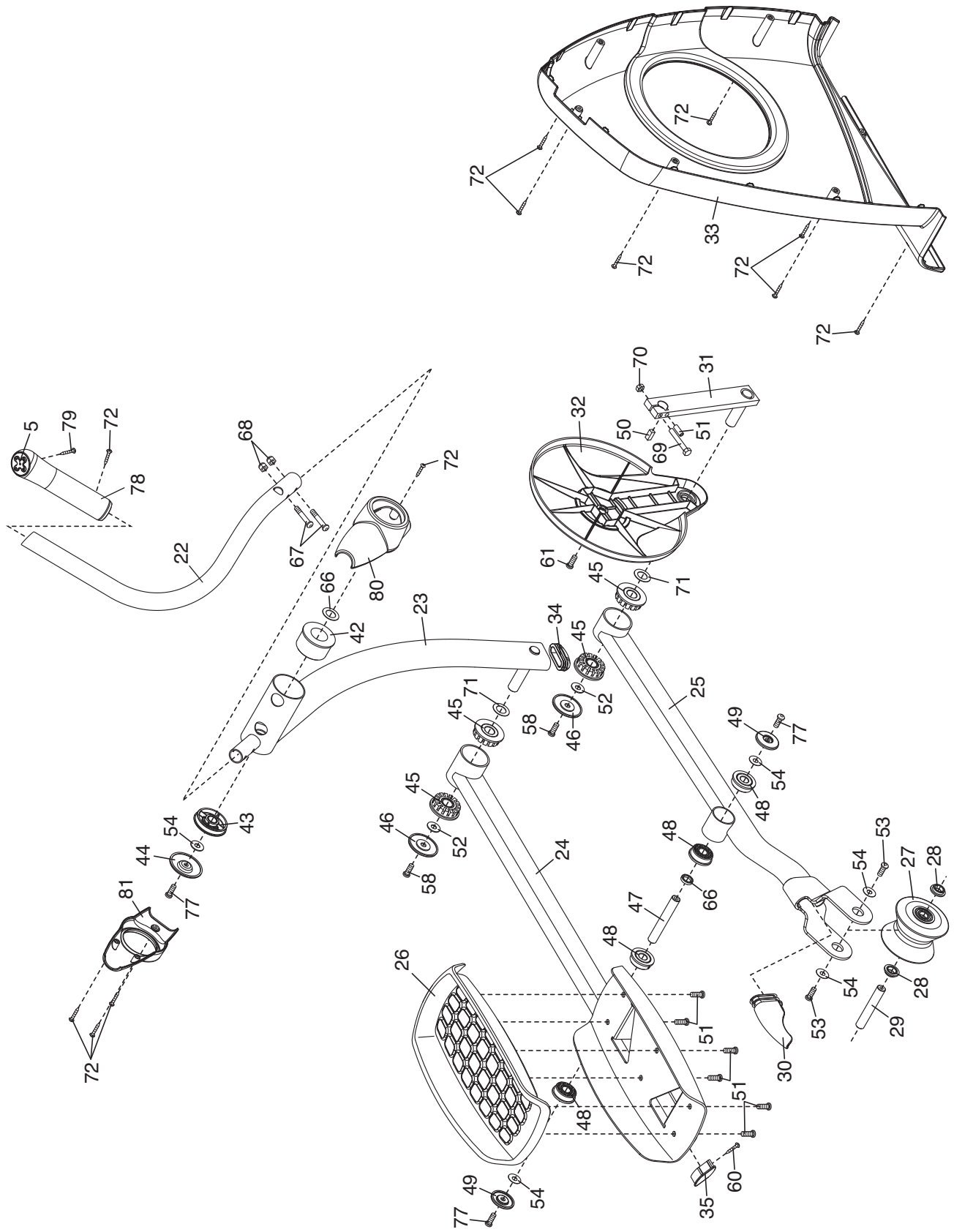

EXPLODED DRAWING B—Model No. PFEL95918.0

R0808A

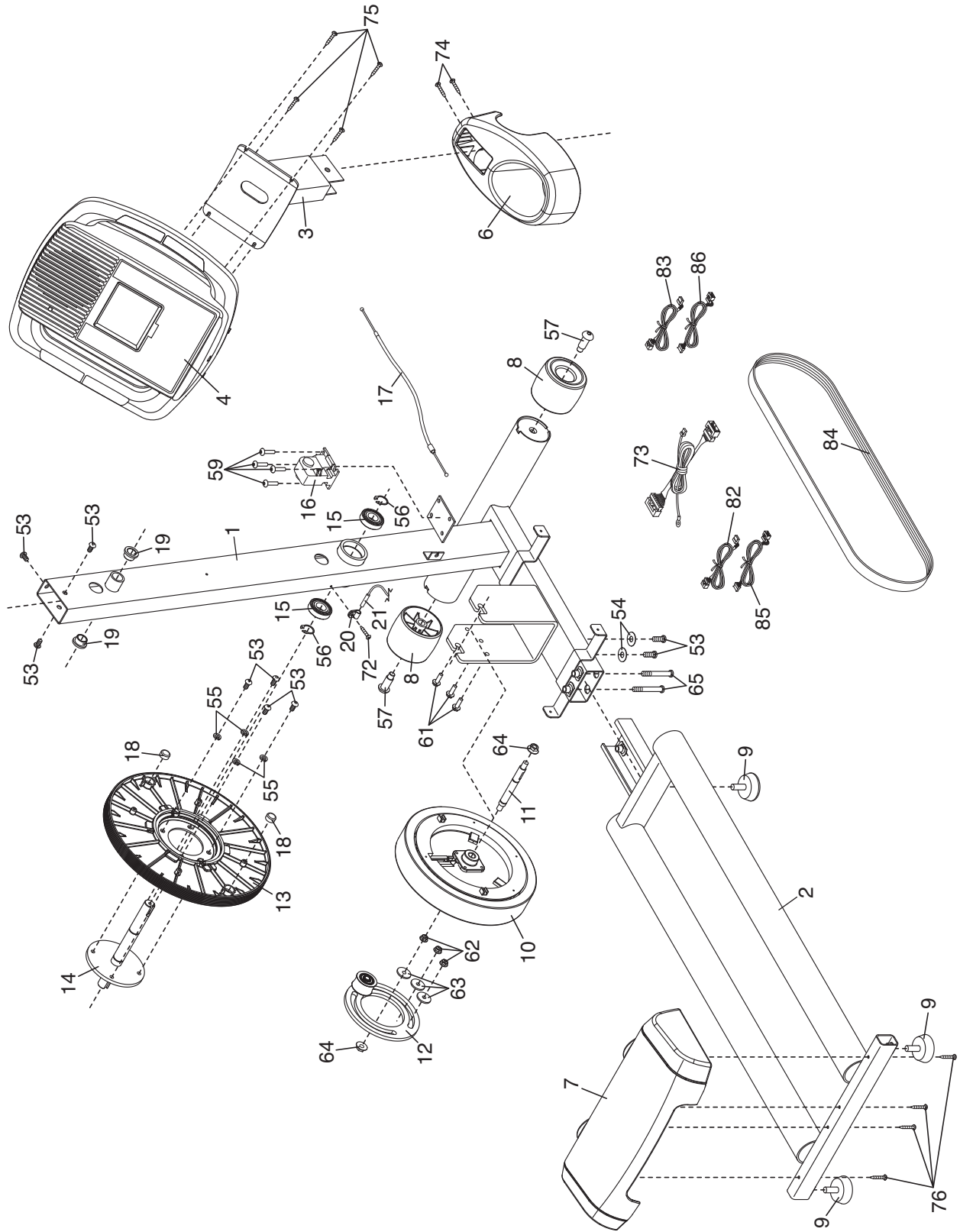

EXPLODED DRAWING C—Model No. PFEL95918.0

R0808A

