

# EXPLODED DRAWING A—Model No. PFEL97910.0

R0210A

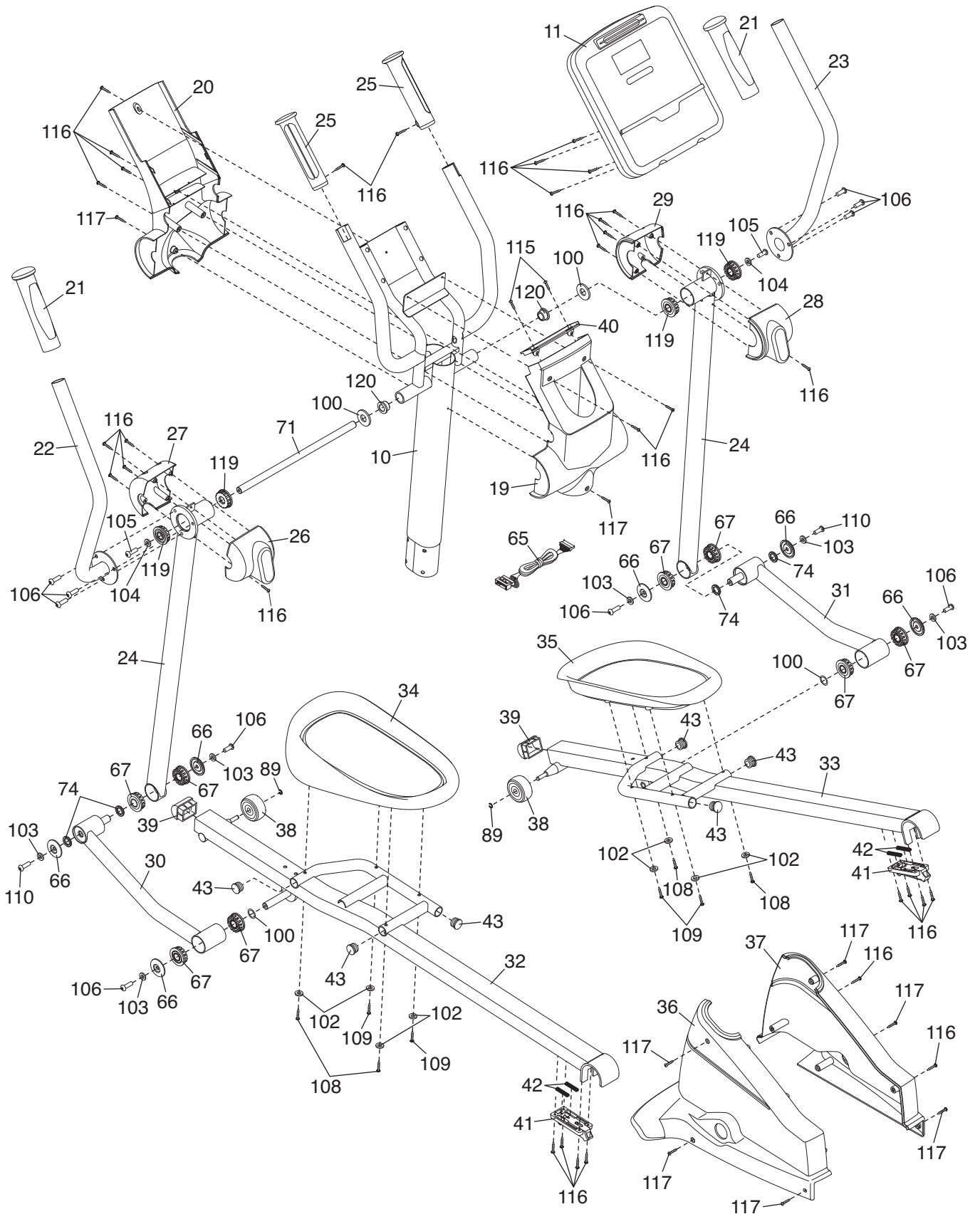

# EXPLODED DRAWING B—Model No. PFEL97910.0

R0210A

