

EXPLODED DRAWING A—Model No. PFEL97918.0

R0808A

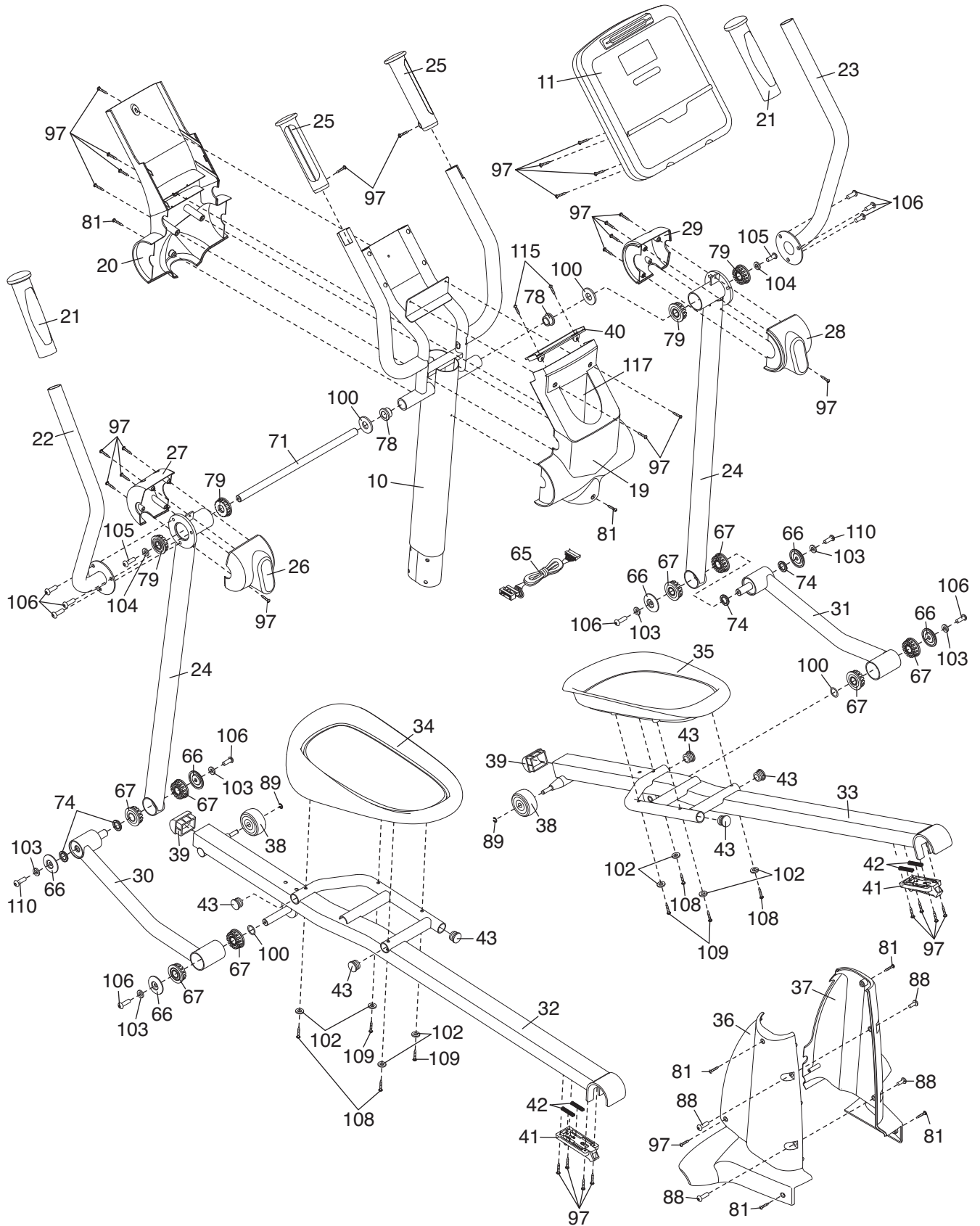

EXPLODED DRAWING B—Model No. PFEL97918.0

R0808A

