

EXPLODED DRAWING A—Model No. PFEL97918.2

R1009A

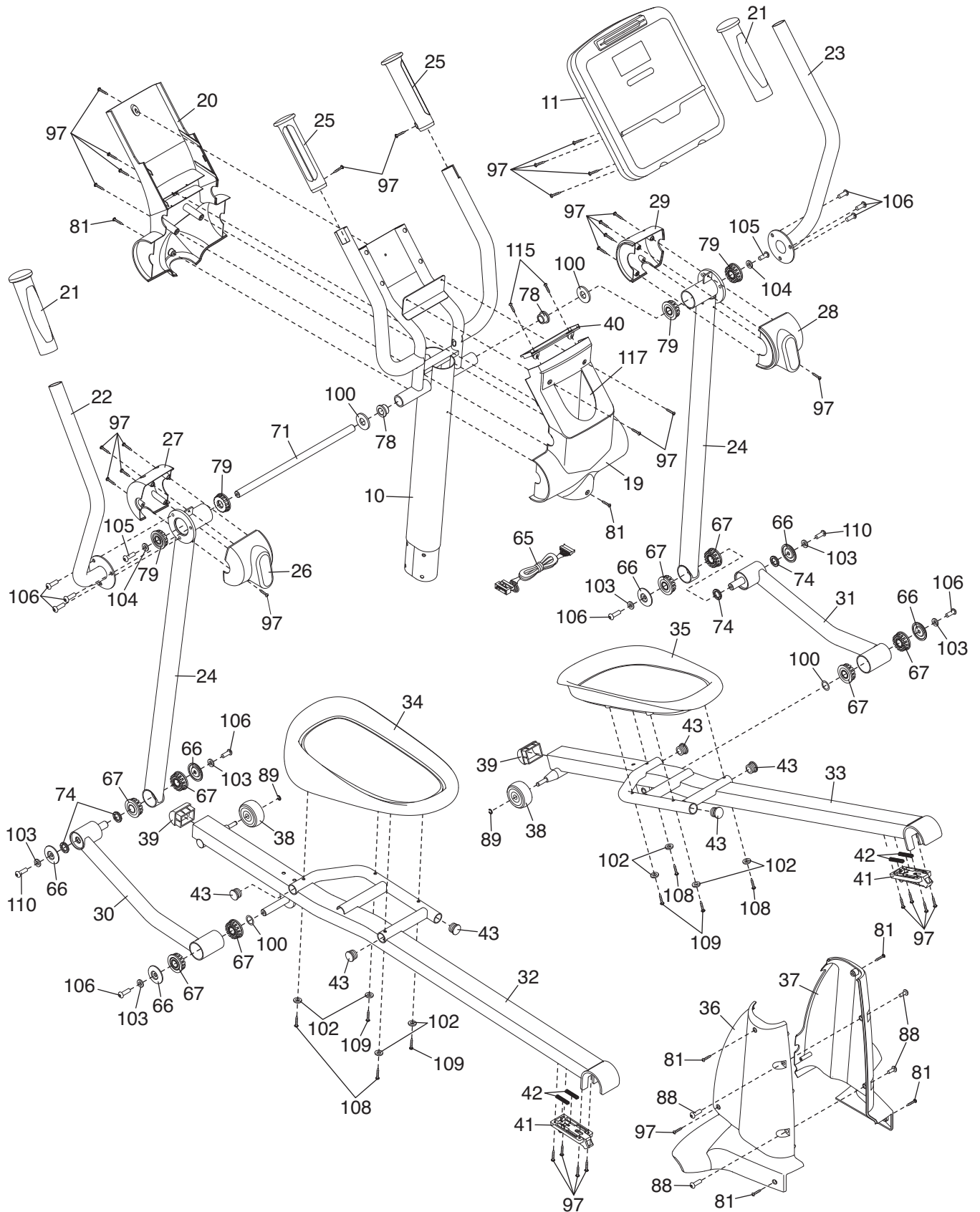

EXPLODED DRAWING B—Model No. PFEL97918.2

R1009A

