

# EXPLODED DRAWING A

Model No. PFEVEL10716.0 R0616A

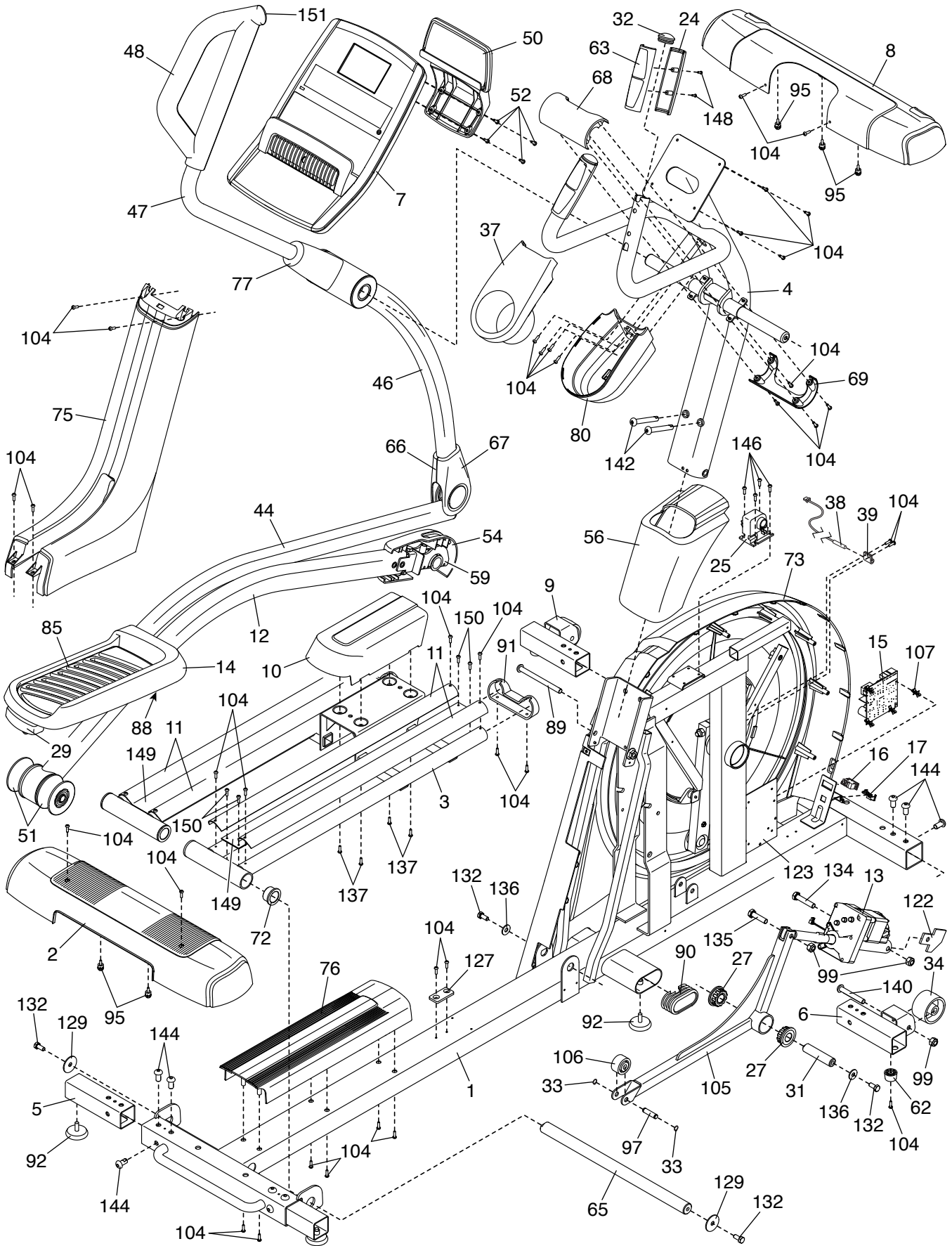

# EXPLODED DRAWING B

Model No. PFEVEL10716.0 R0616A

