

EXPLODED DRAWING A

Model No. PFEVEL39716.0 R0116A

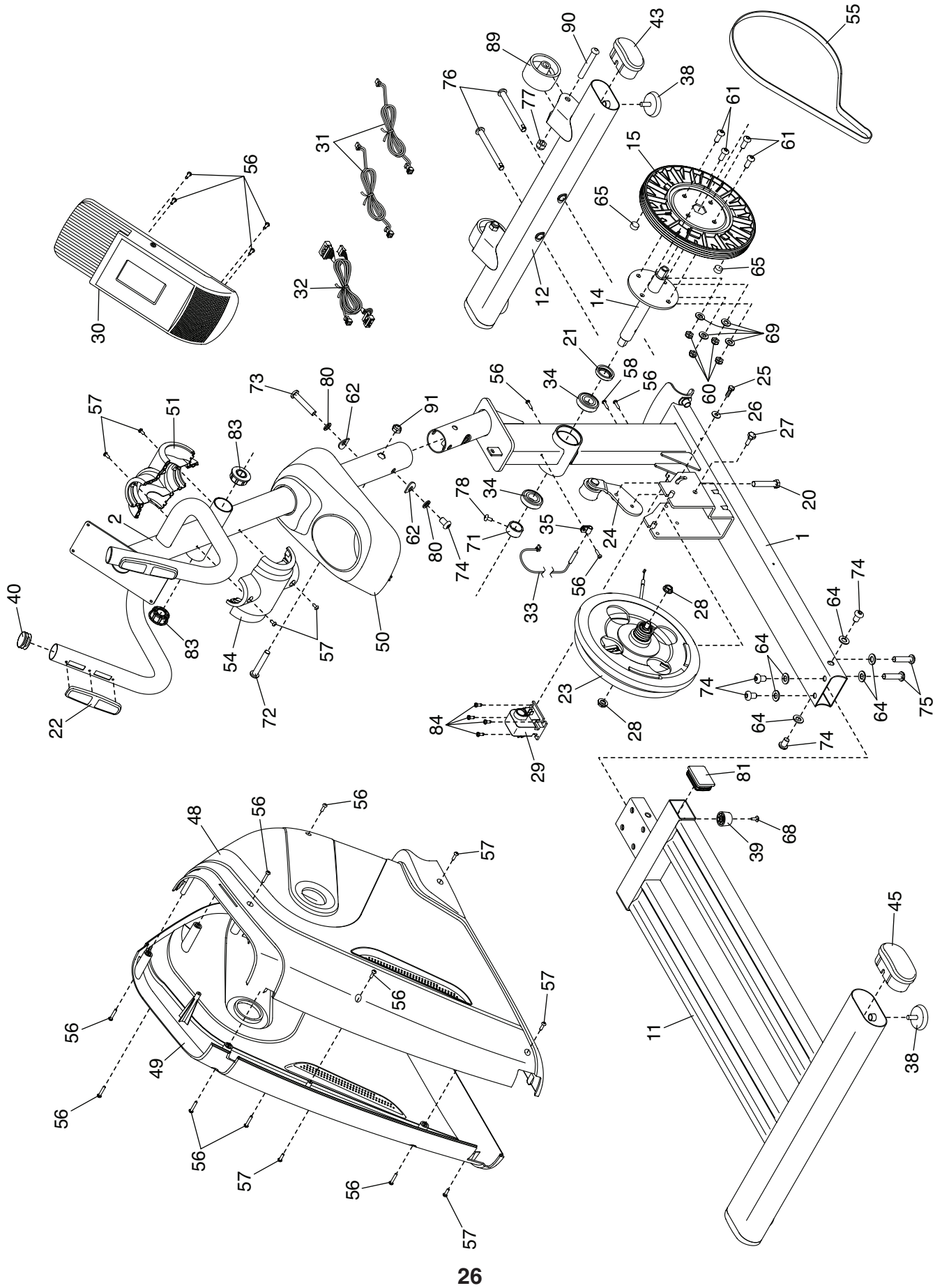

EXPLODED DRAWING B

Model No. PFEVEL39716.0 R0116A

