

EXPLODED DRAWING A

Model No. PFEVEL49716.0 R0916A

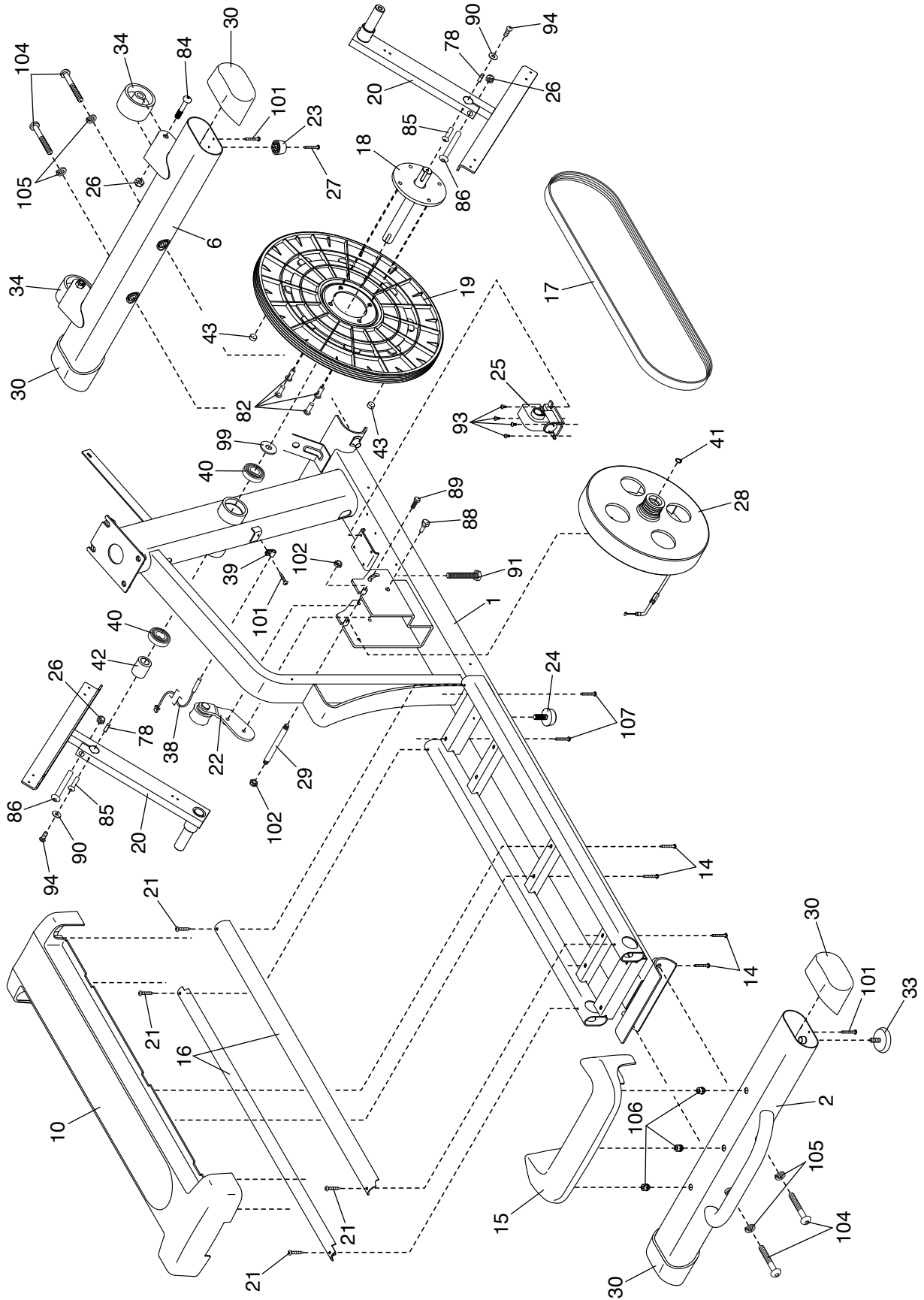

EXPLODED DRAWING B

Model No. PFEVEL49716.0 R0916A

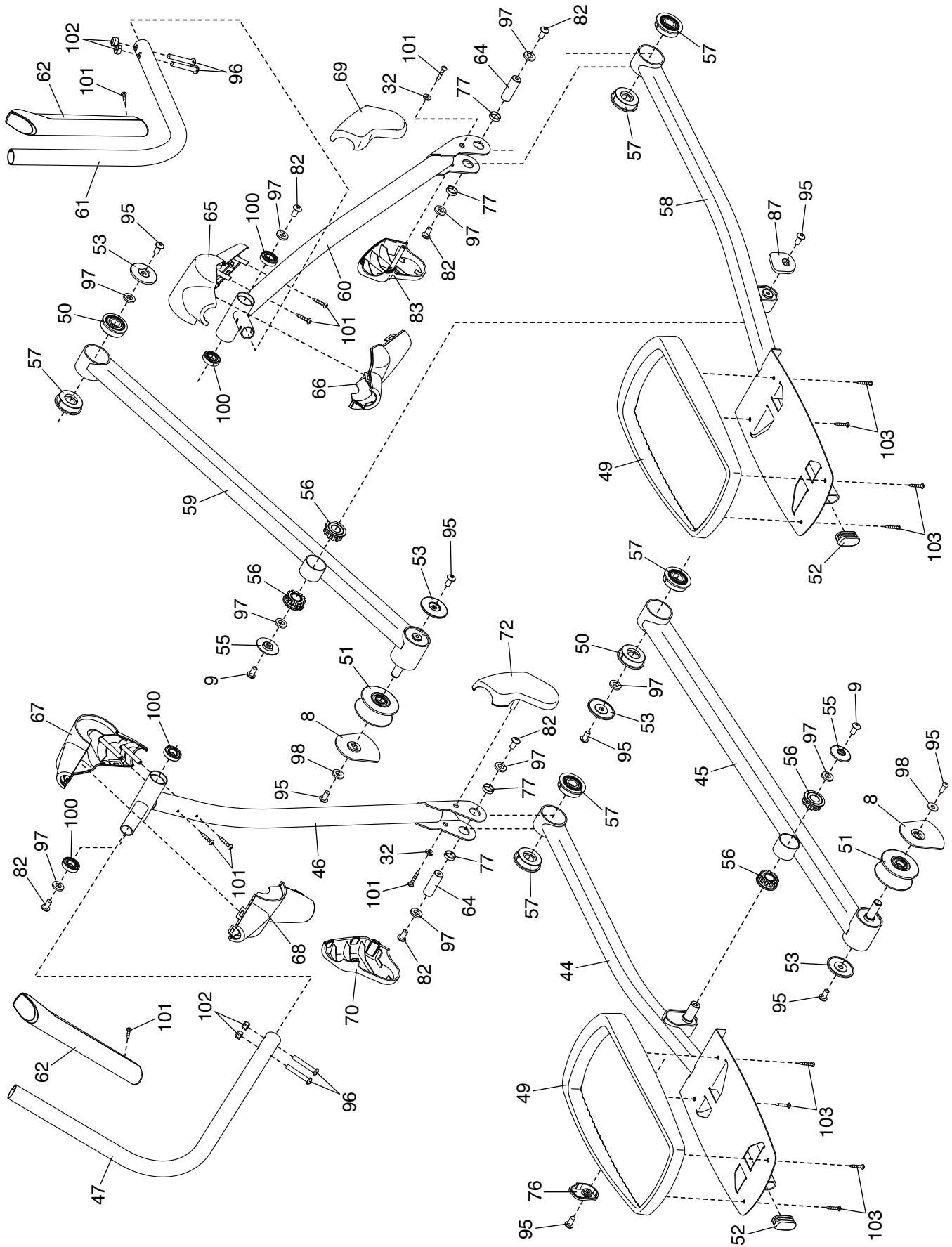

EXPLODED DRAWING C

Model No. PFEVEL49716.0 R0916A

