

EXPLODED DRAWING A

Model No. PFEVEL60717.0 R0517A

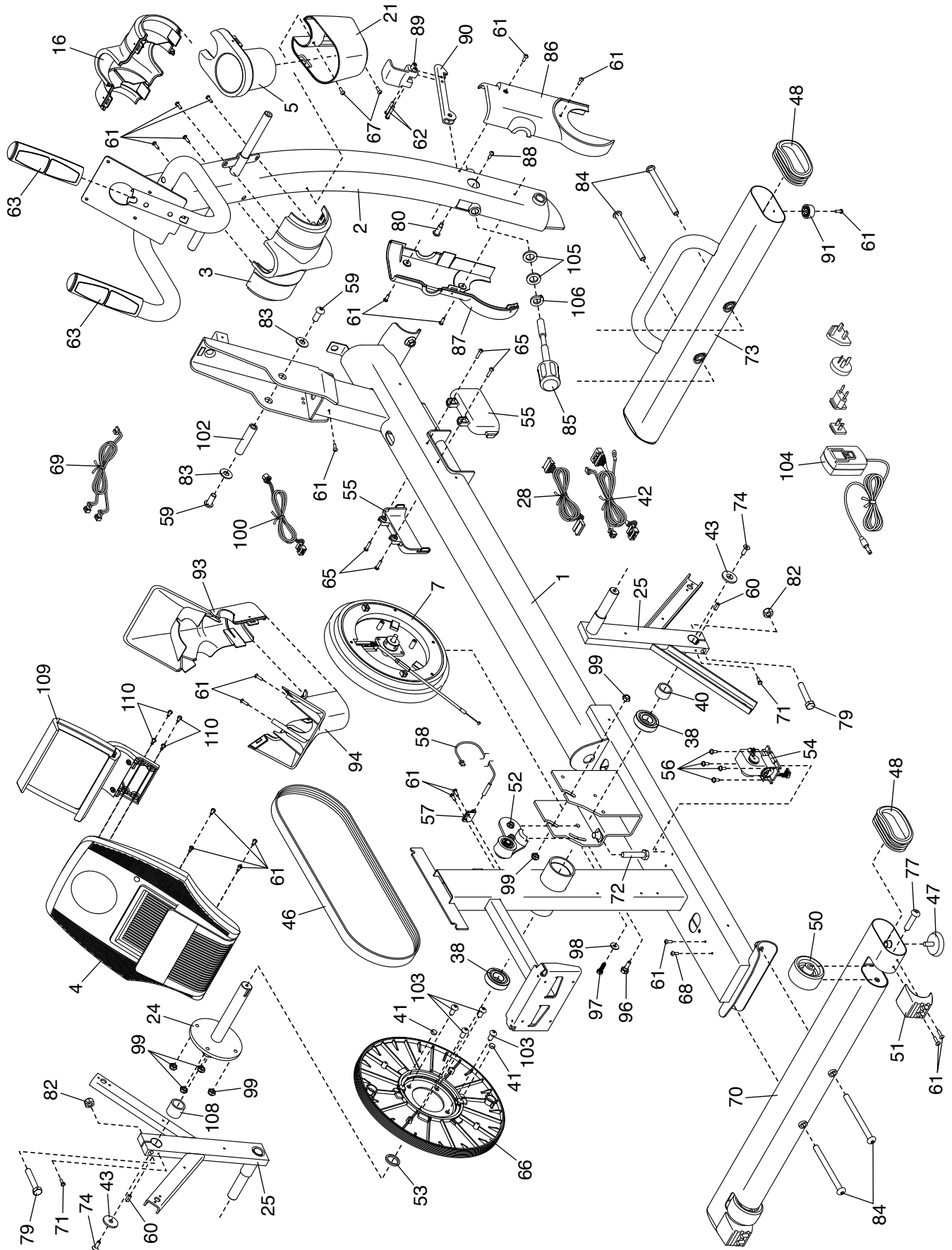

EXPLODED DRAWING B

Model No. PFEVEL60717.0 R0517A

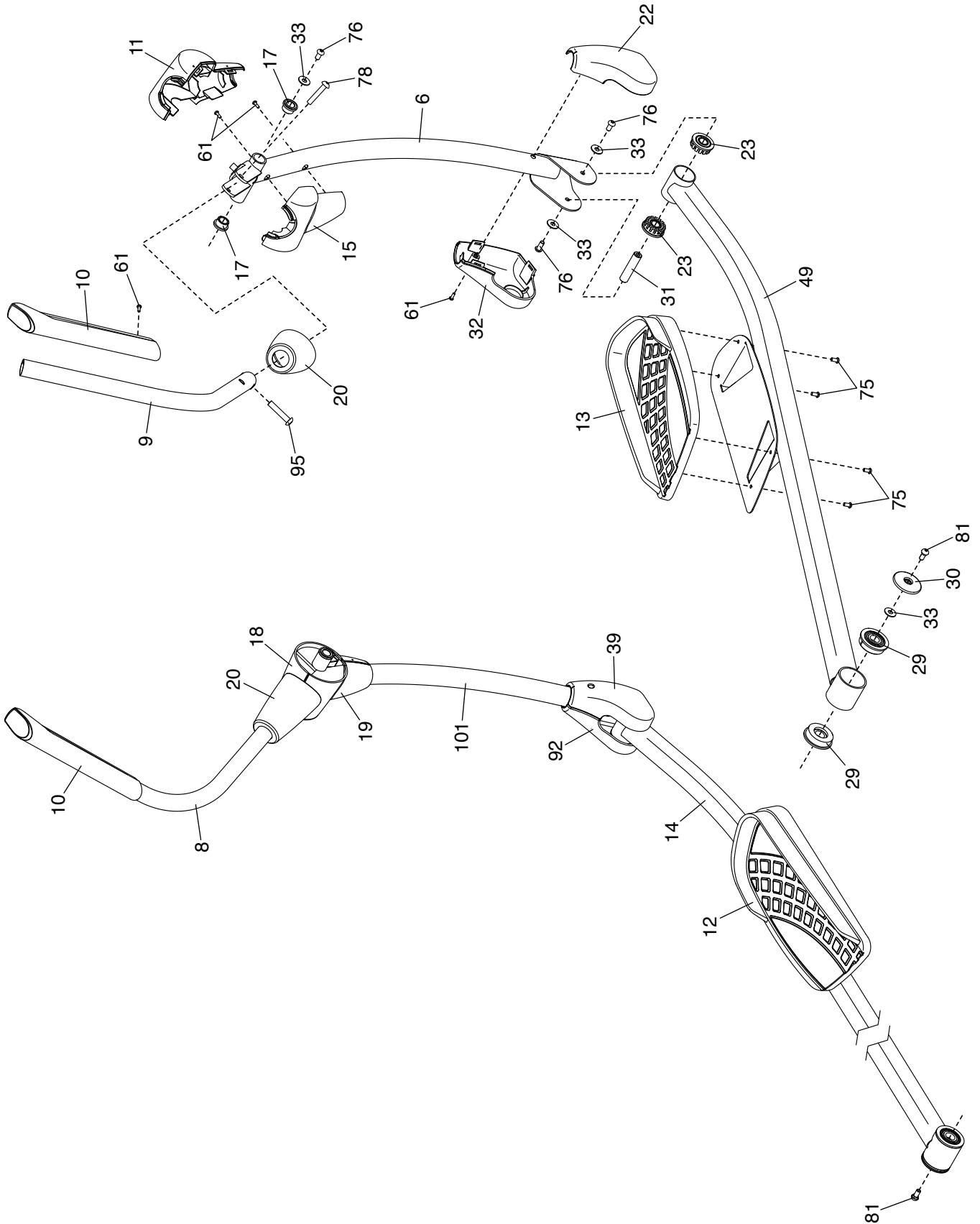

EXPLODED DRAWING C

Model No. PFEVEL60717.0 R0517A

