

EXPLODED DRAWING A

Model No. PFEVEL72912.0 R0312A

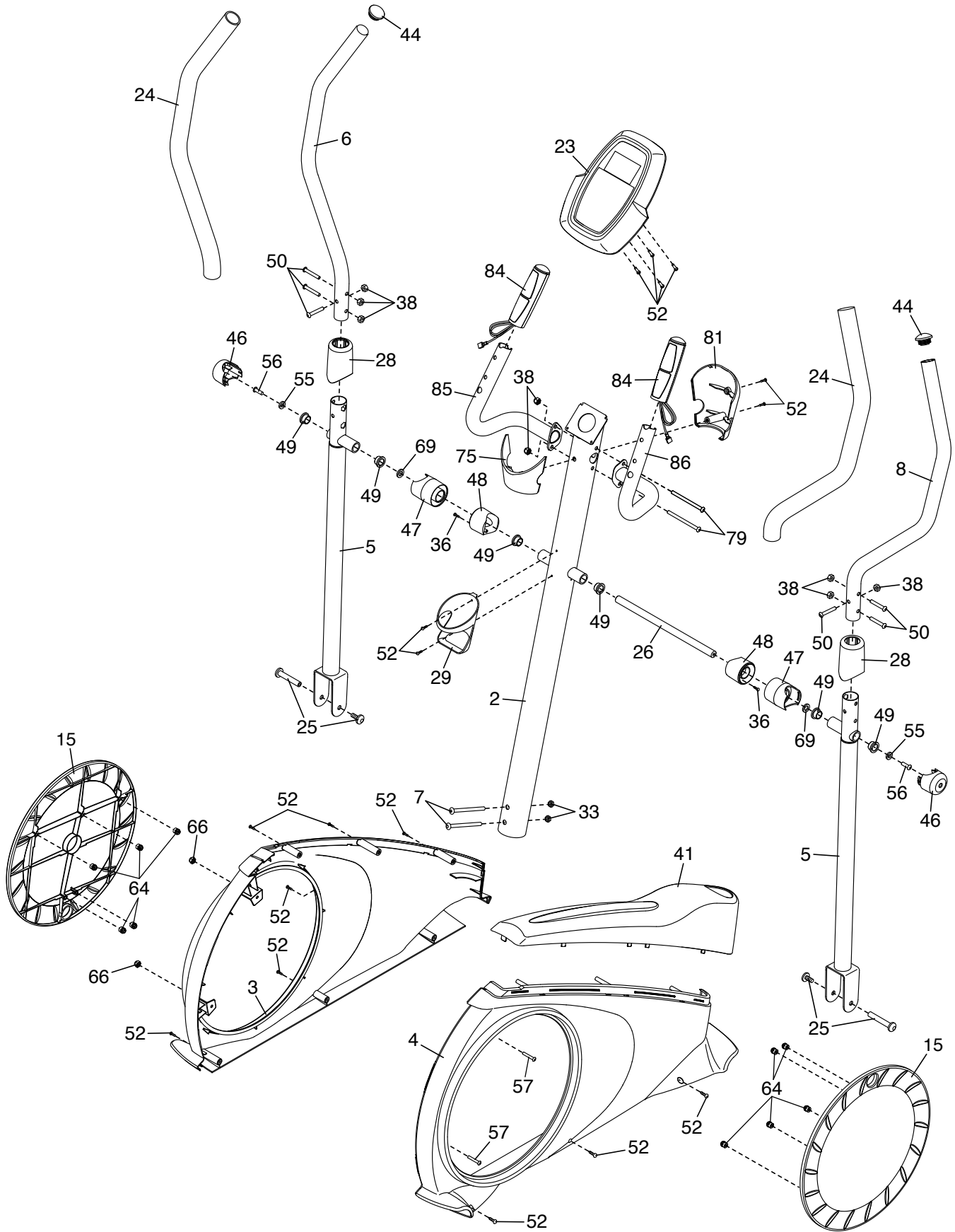

EXPLODED DRAWING B

Model No. PFEVEL72912.0 R0312A

