

EXPLODED DRAWING A

Model No. PFEVEL73912.1 R0512A

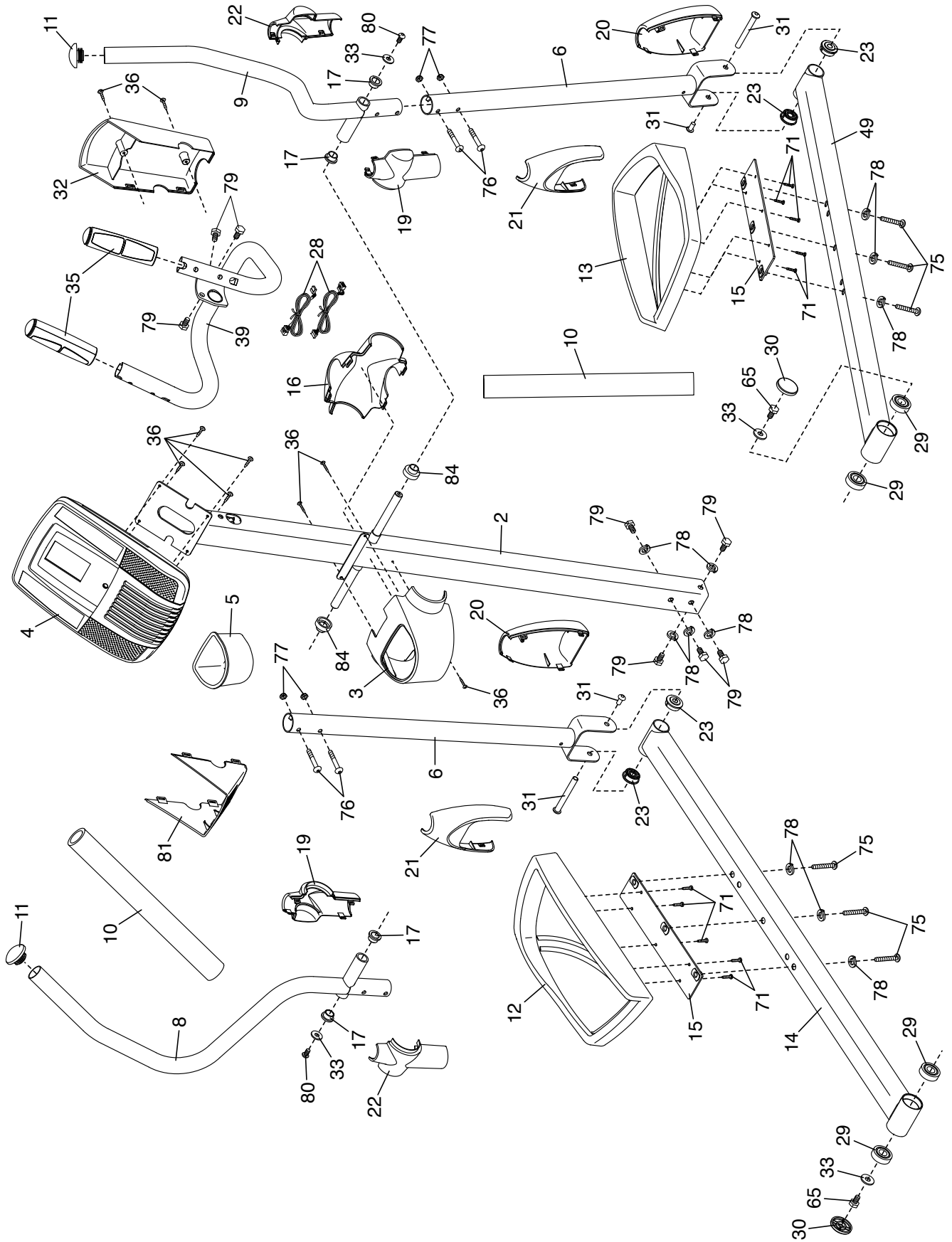

EXPLODED DRAWING B

Model No. PFEVEL73912.1 R0512A

