

EXPLODED DRAWING A

Model No. PFEVEL74917.1 R0818A

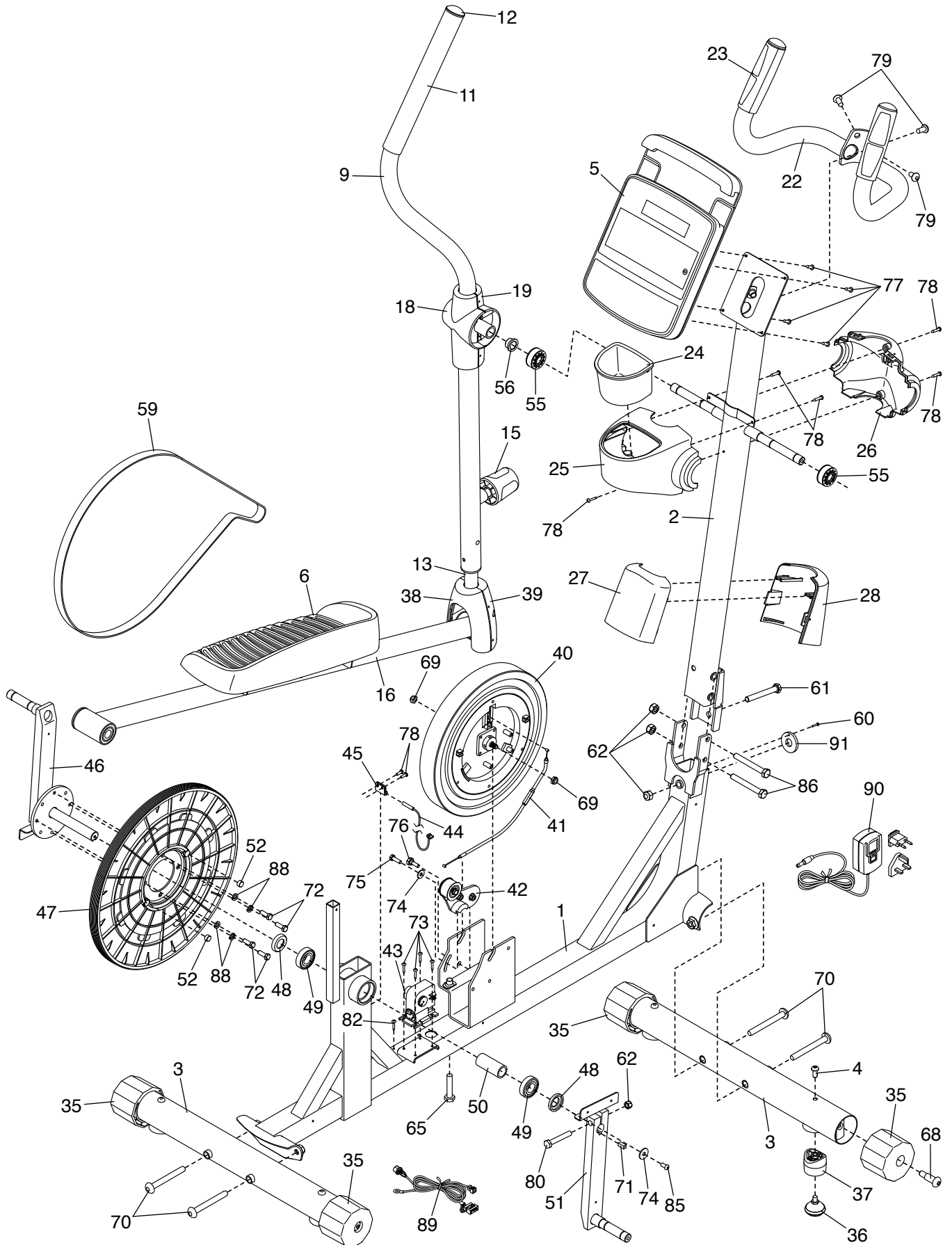

EXPLODED DRAWING B

Model No. PFEVEL74917.1 R0818A

