

# EXPLODED DRAWING A

Model No. PFEVEL81019.2 R0420A

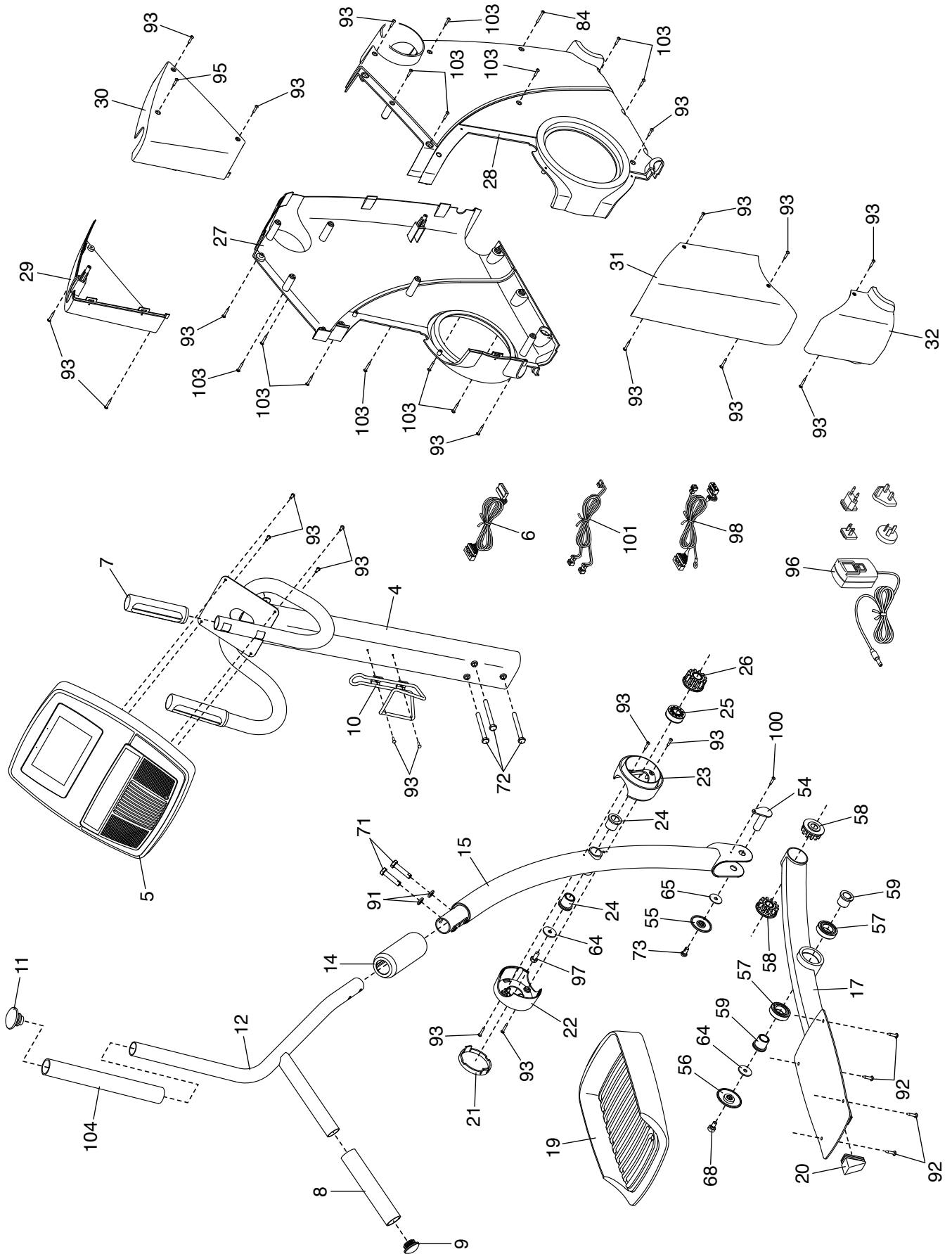

# EXPLODED DRAWING B

Model No. PFEVEL81019.2 R0420A

