

# EXPLODED DRAWING A

Model No. PFEVEL83913.0 R0913A

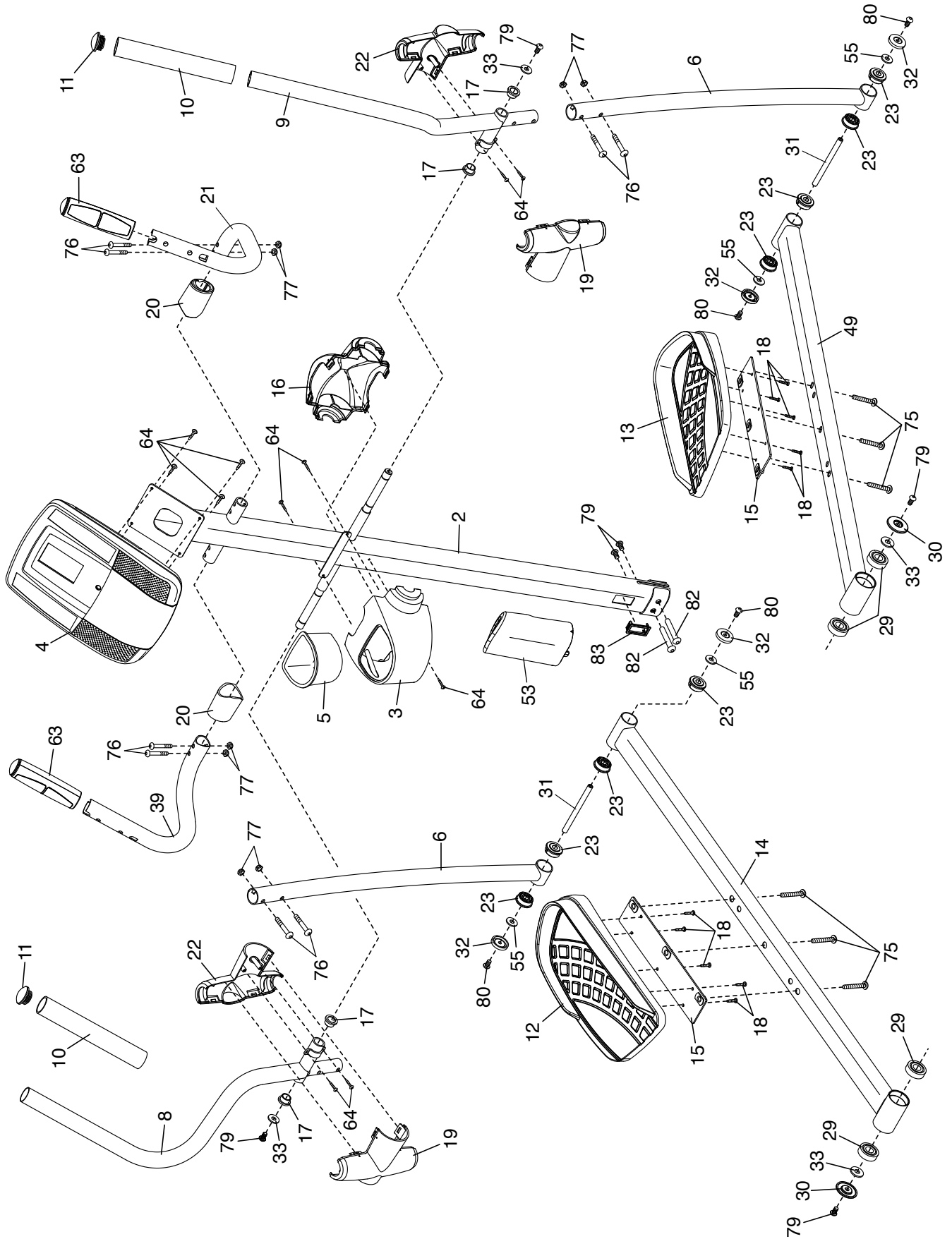

# EXPLODED DRAWING B

Model No. PFEVEL83913.0 R0913A

