

EXPLODED DRAWING A

Model No. PFEVEL89716.0 R0818A

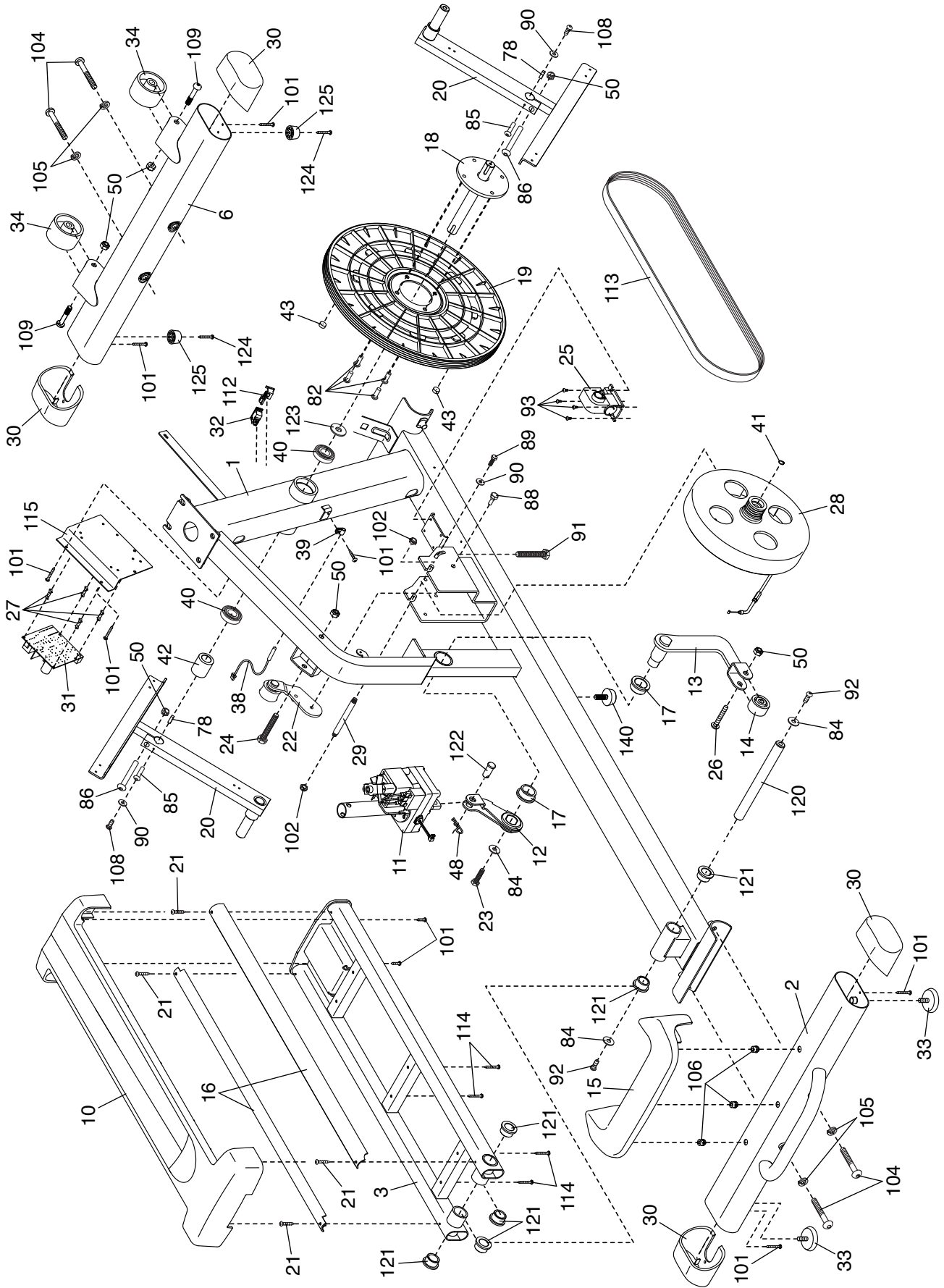

EXPLODED DRAWING B

Model No. PFEVEL89716.0 R0818A

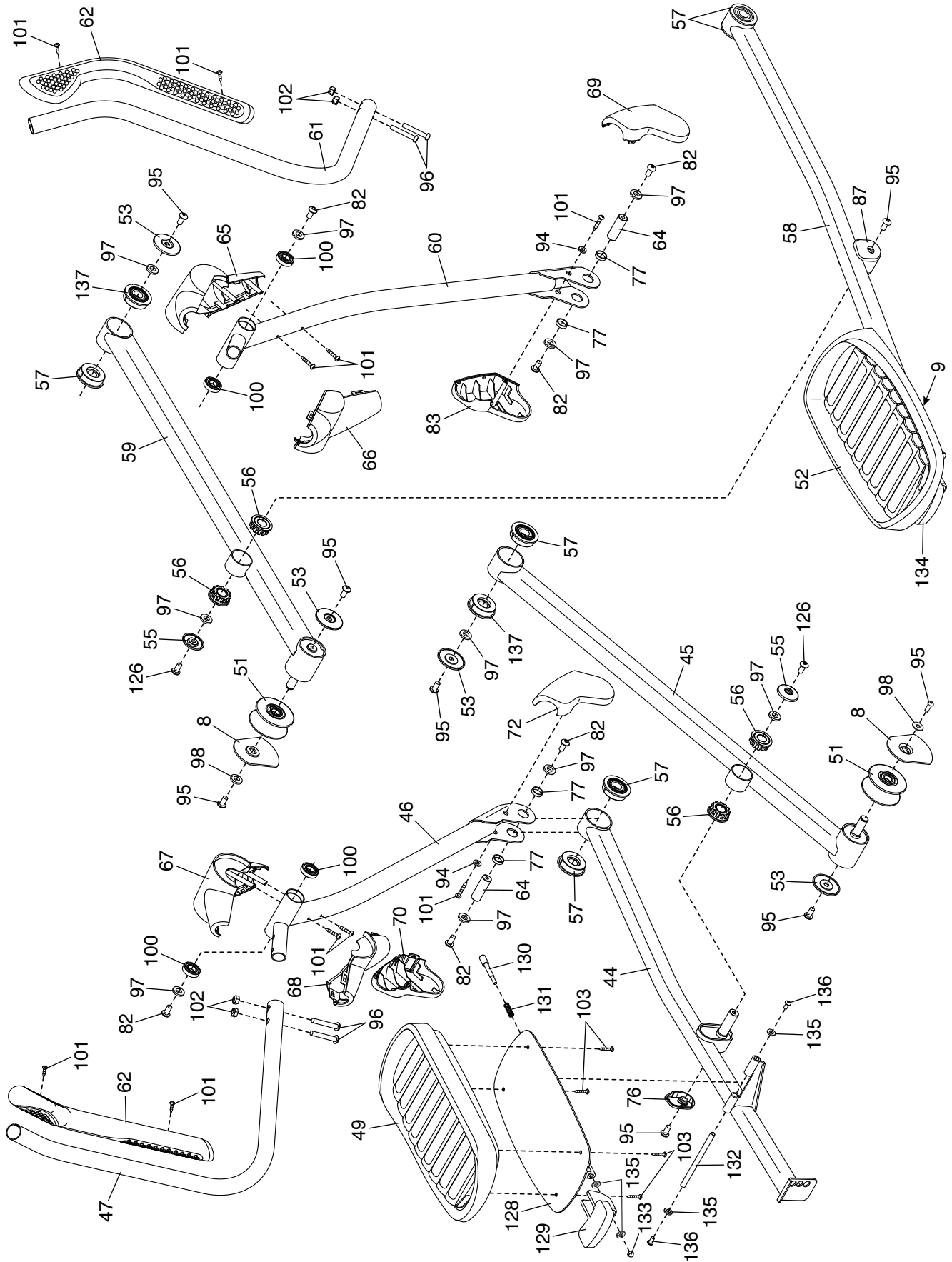

EXPLODED DRAWING C

Model No. PFEVEL89716.0 R0818A

