

EXPLODED DRAWING A

Model No. PFEVEL98014.1 R0514A

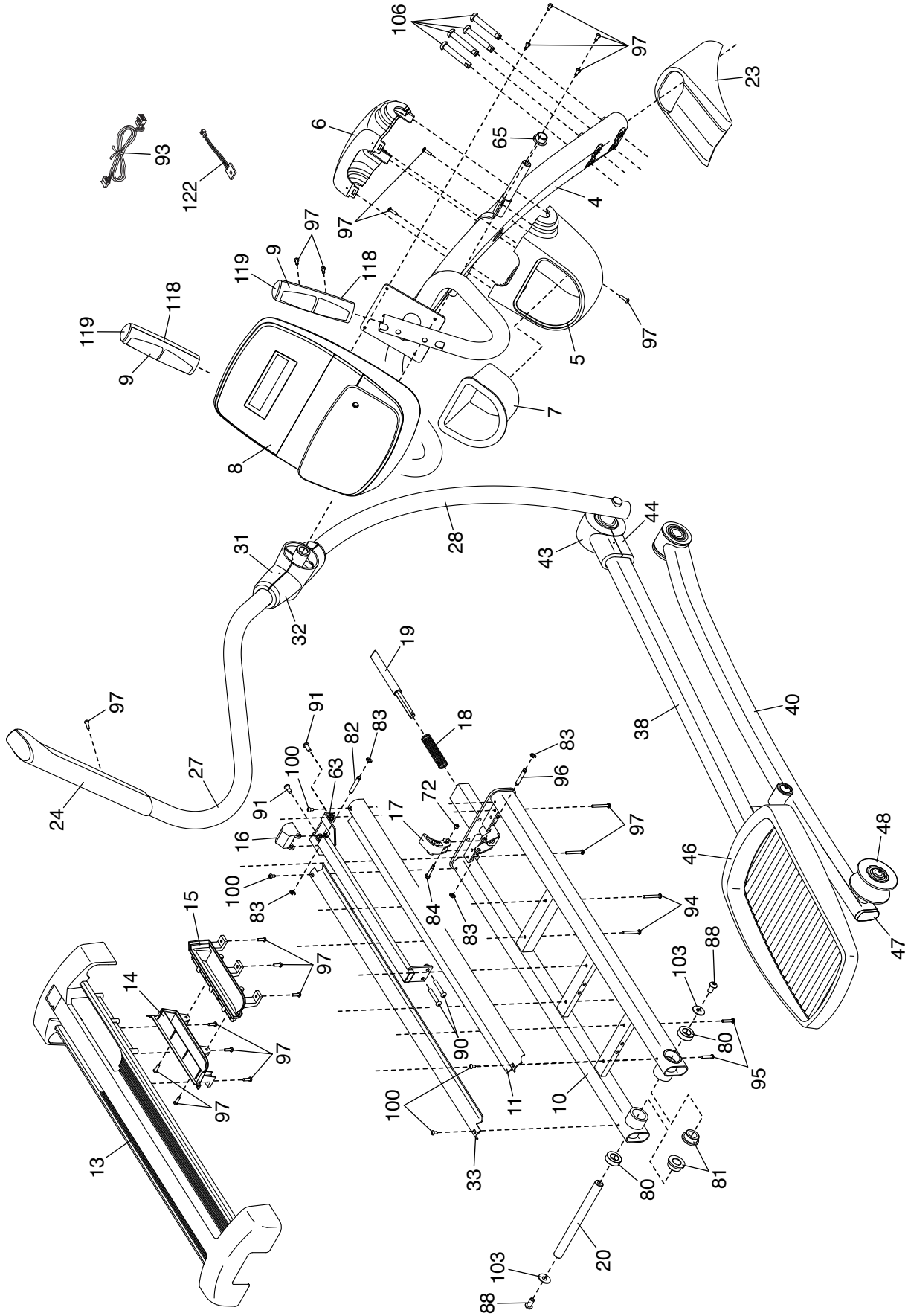

EXPLODED DRAWING B

Model No. PFEVEL98014.1 R0514A

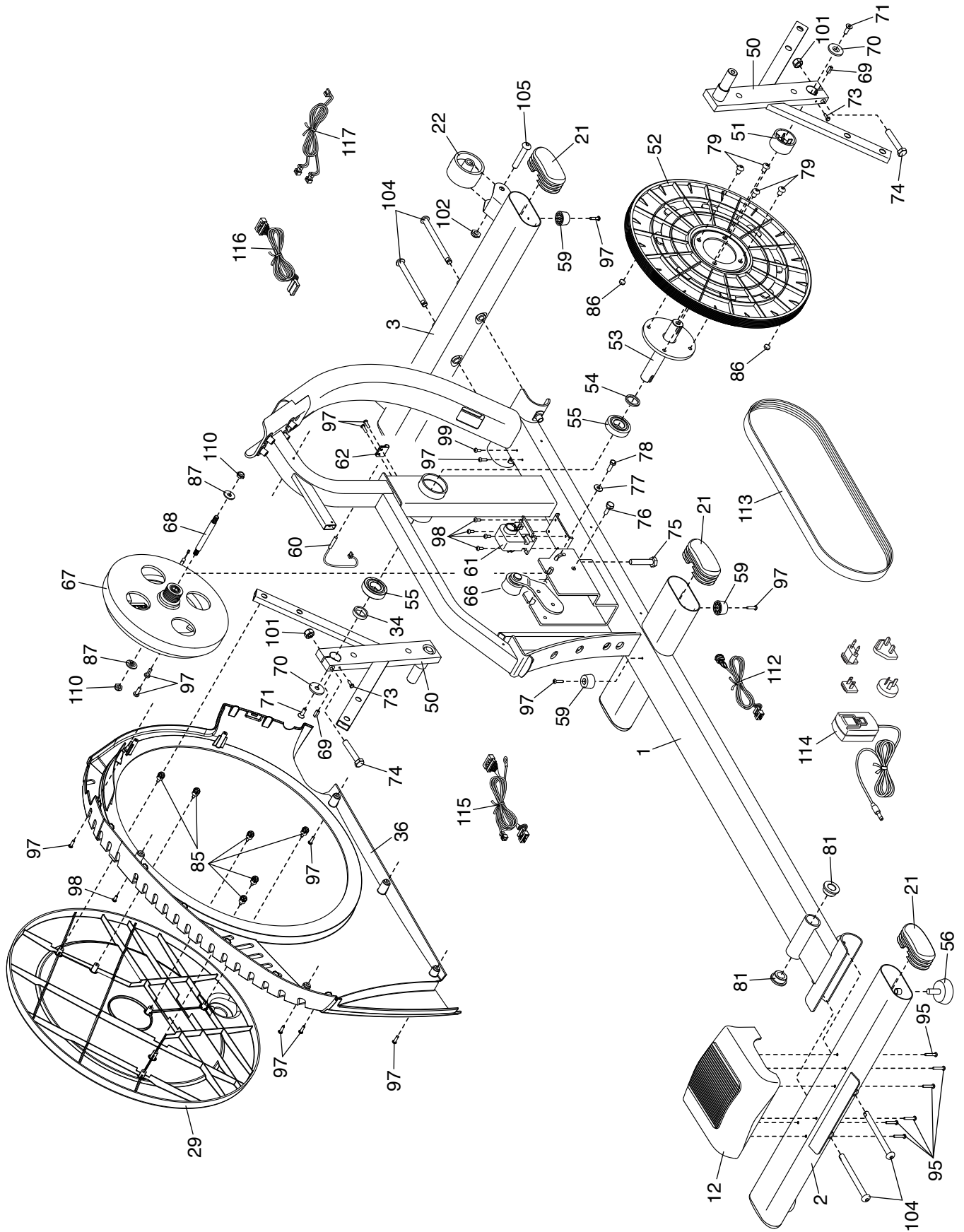

EXPLODED DRAWING C

Model No. PFEVEL98014.1 R0514A

