

# EXPLODED DRAWING A—Model No. PFEX03409.0

R0709A

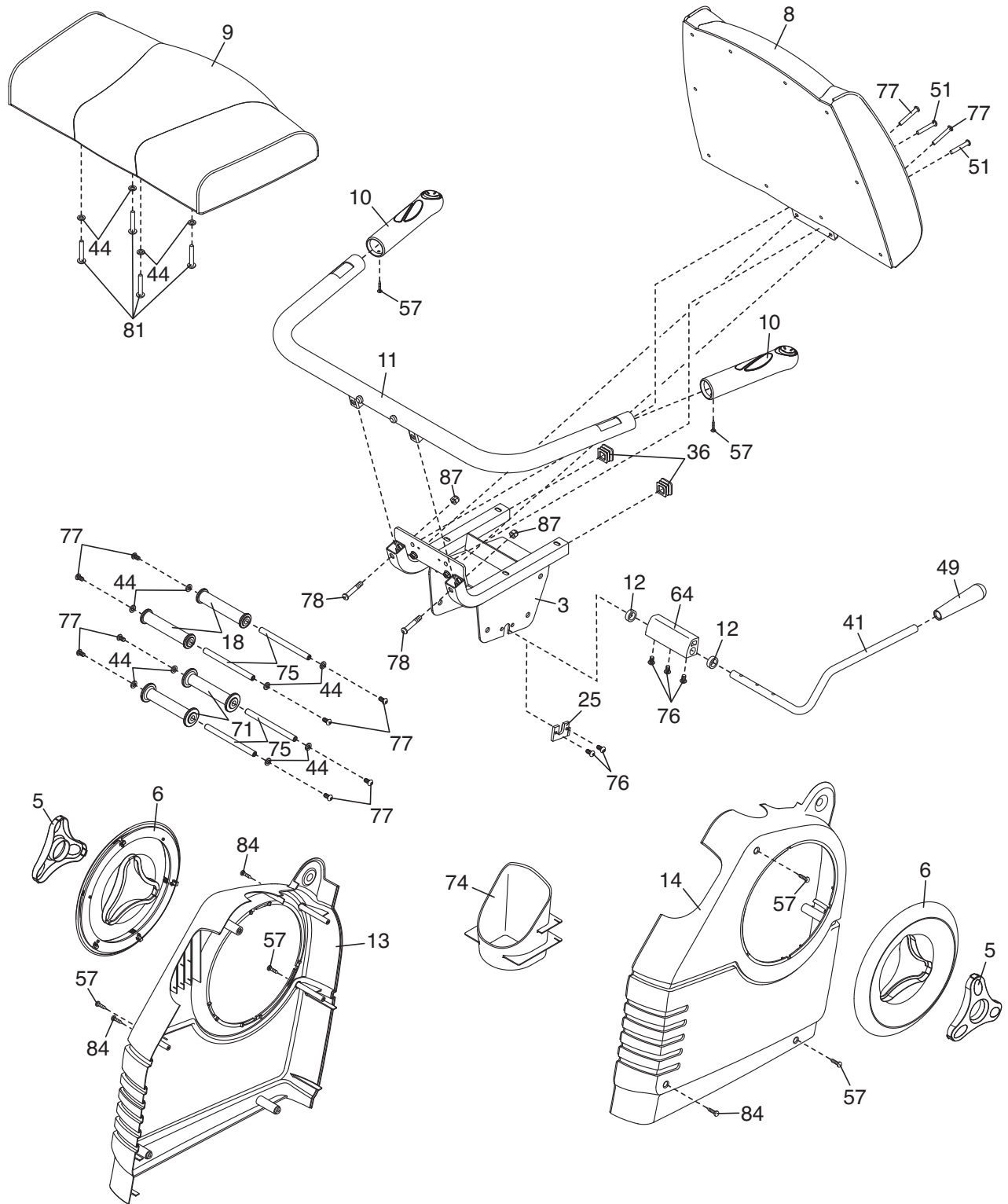

# EXPLODED DRAWING B—Model No. PFEX03409.0

R0709A

