

EXPLODED DRAWING A

Model No. PFEX16718.3 R1219A

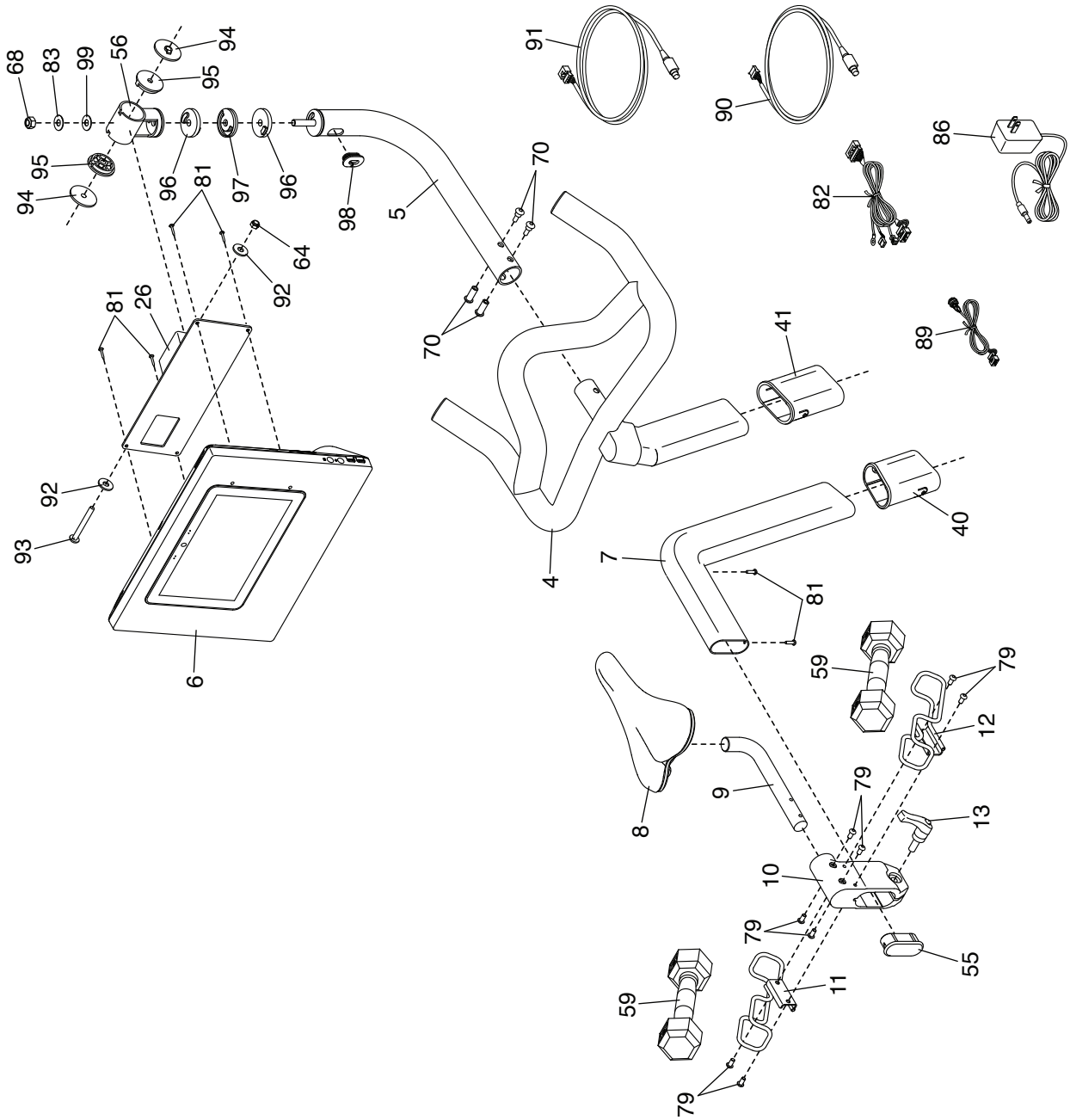

EXPLODED DRAWING B

Model No. PFEX16718.3 R1219A

