

EXPLODED DRAWING A

Model No. PFEX17914.0 R1214A

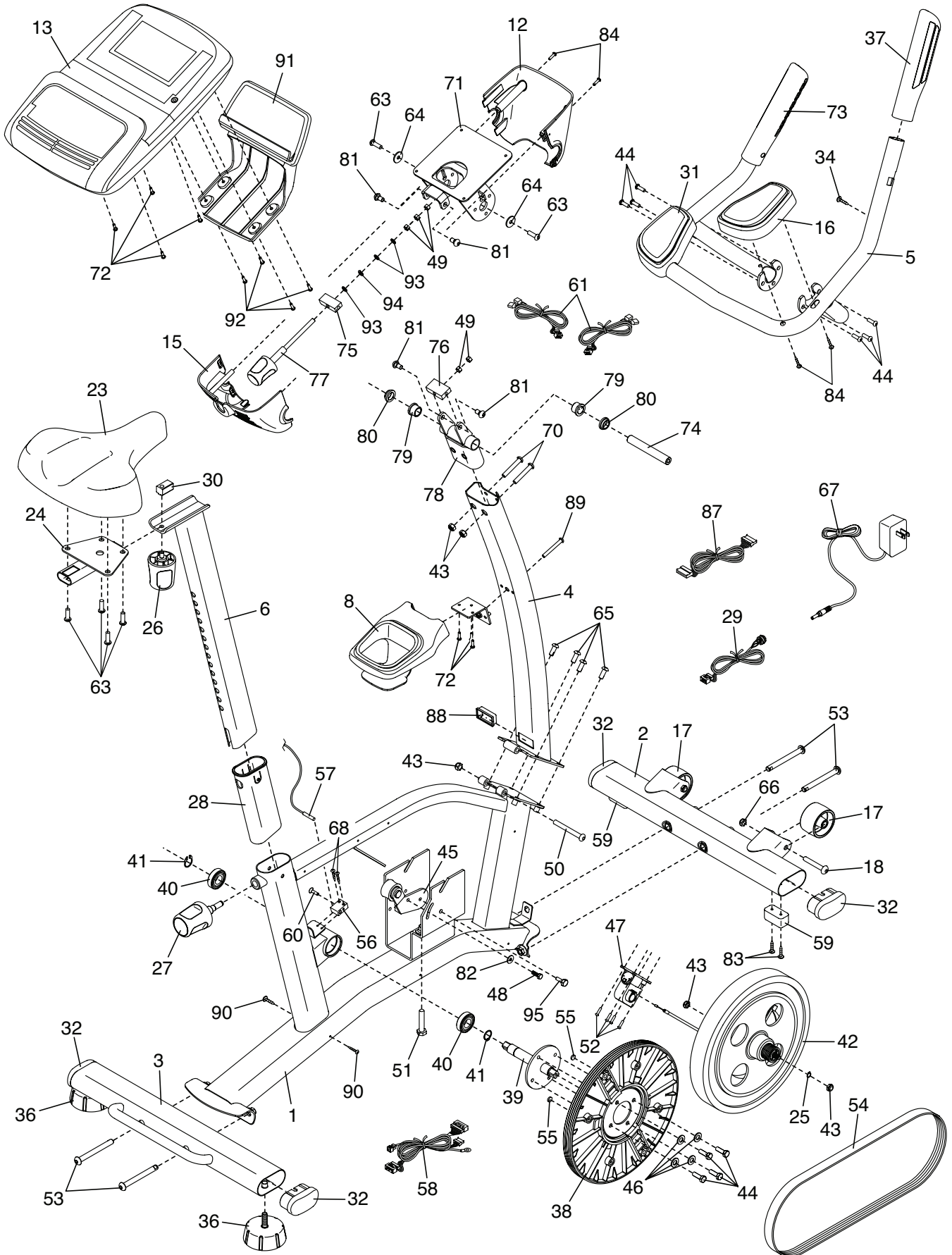

EXPLODED DRAWING B

Model No. PFEX17914.0 R1214A

