

EXPLODED DRAWING A

Model No. PFEX17914.1 R0418A

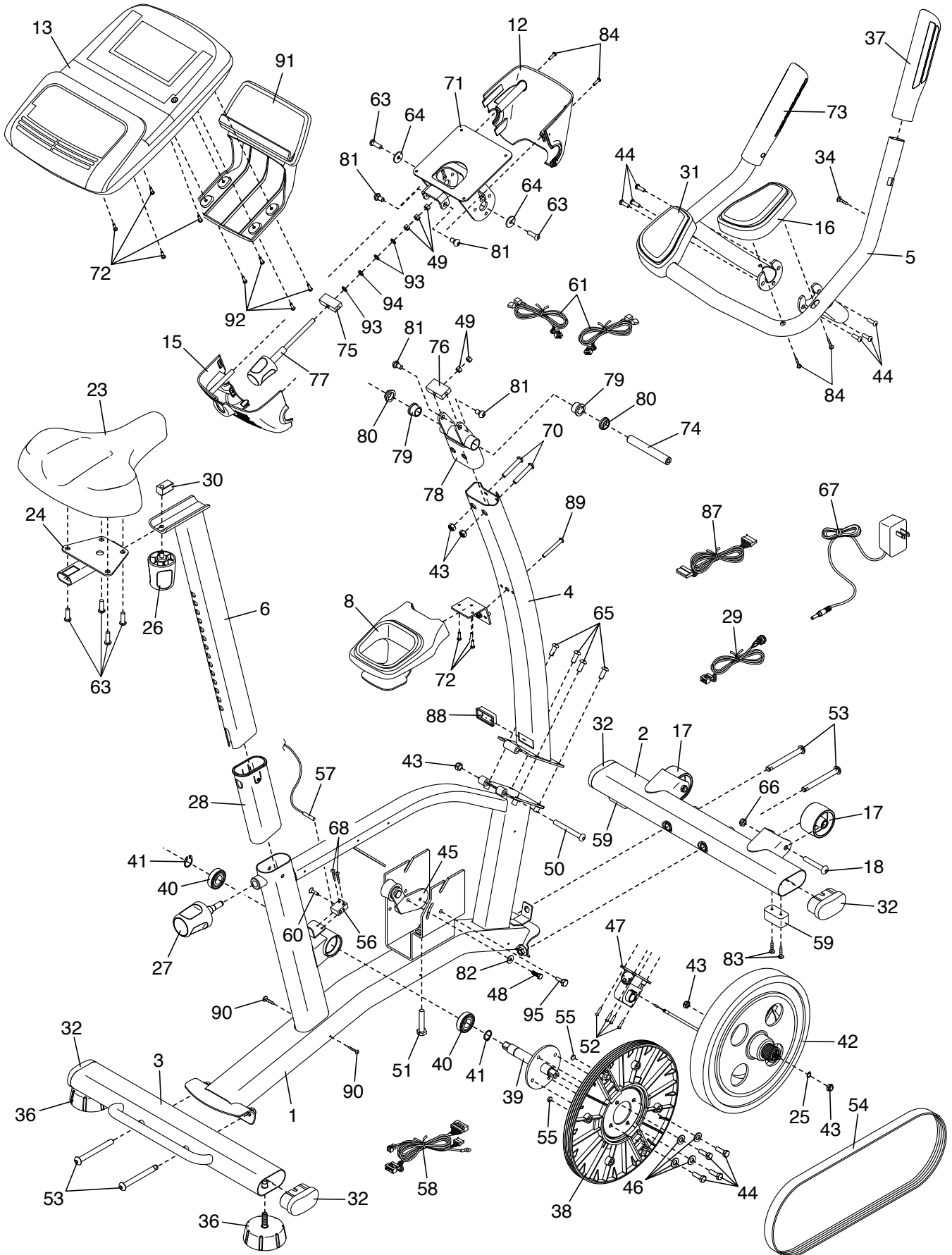

EXPLODED DRAWING B

Model No. PFEX17914.1 R0418A

