

EXPLODED DRAWING A

Model No. PFEX30124.1 R0723A

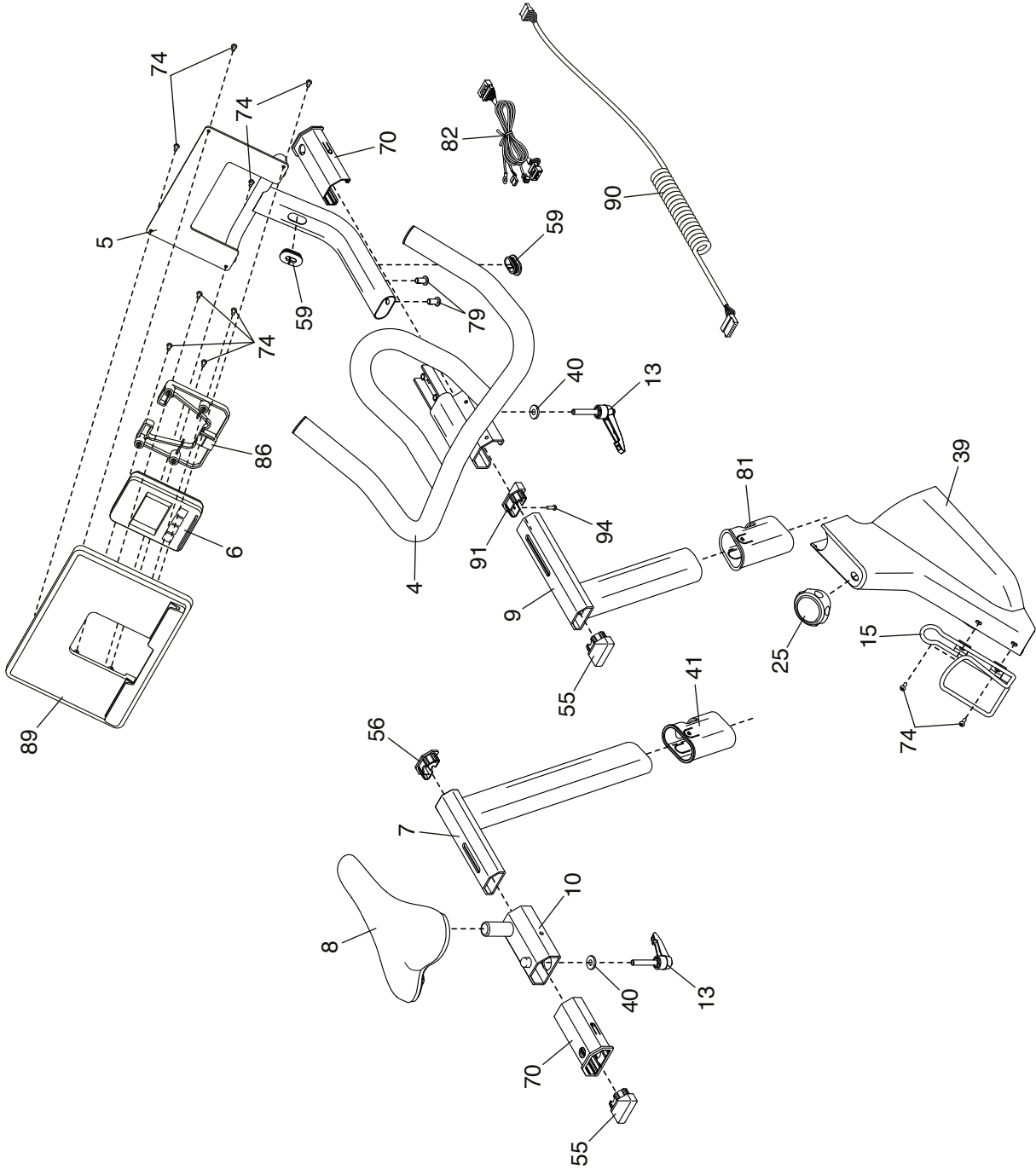

EXPLODED DRAWING B

Model No. PFEX30124.1 R0723A

