

EXPLODED DRAWING A

Model No. PFEX30124.2 R1023A

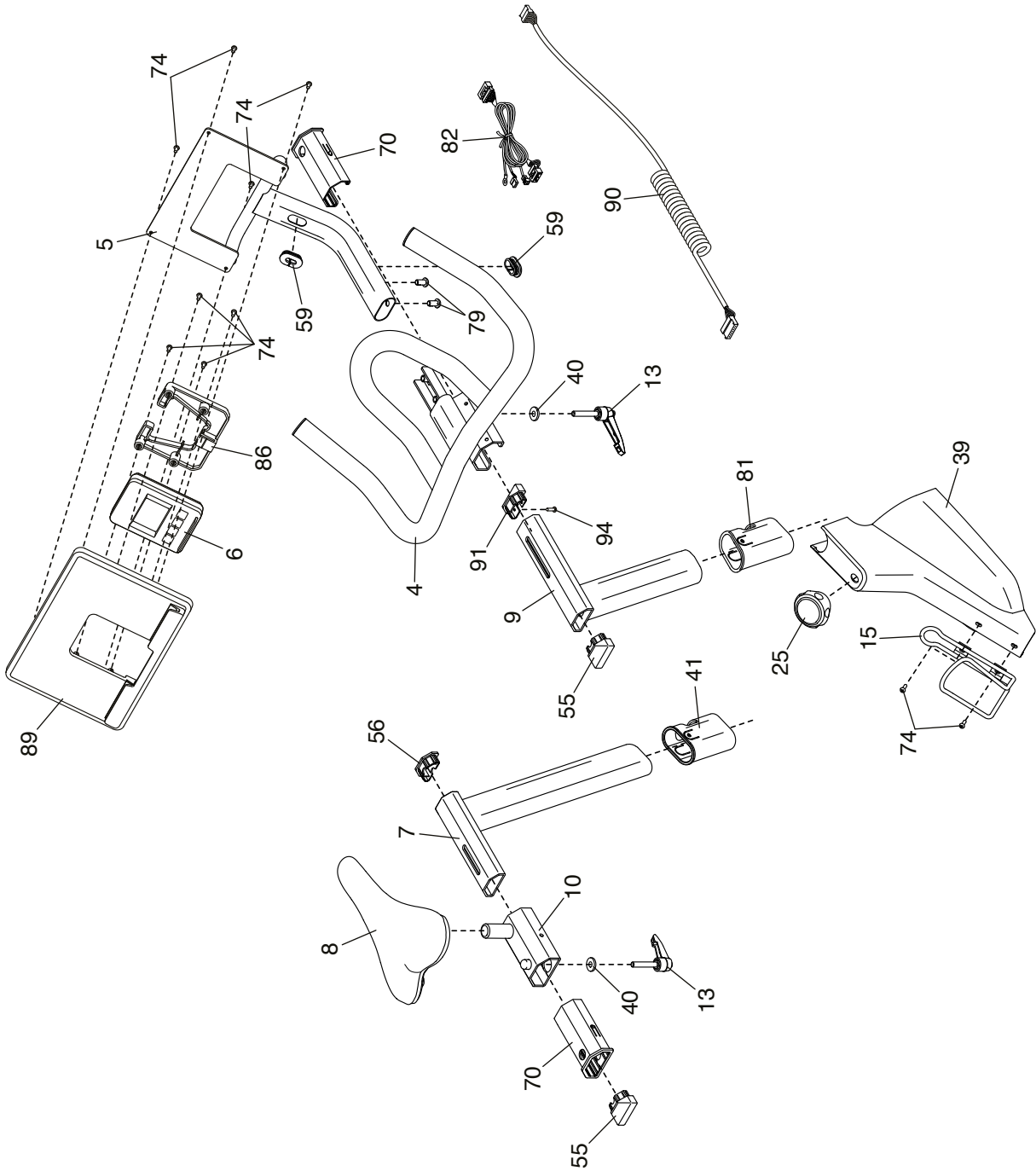

EXPLODED DRAWING B

Model No. PFEX30124.2 R1023A

