

# EXPLODED DRAWING A

Model No. PFEX30124.3 R1123A

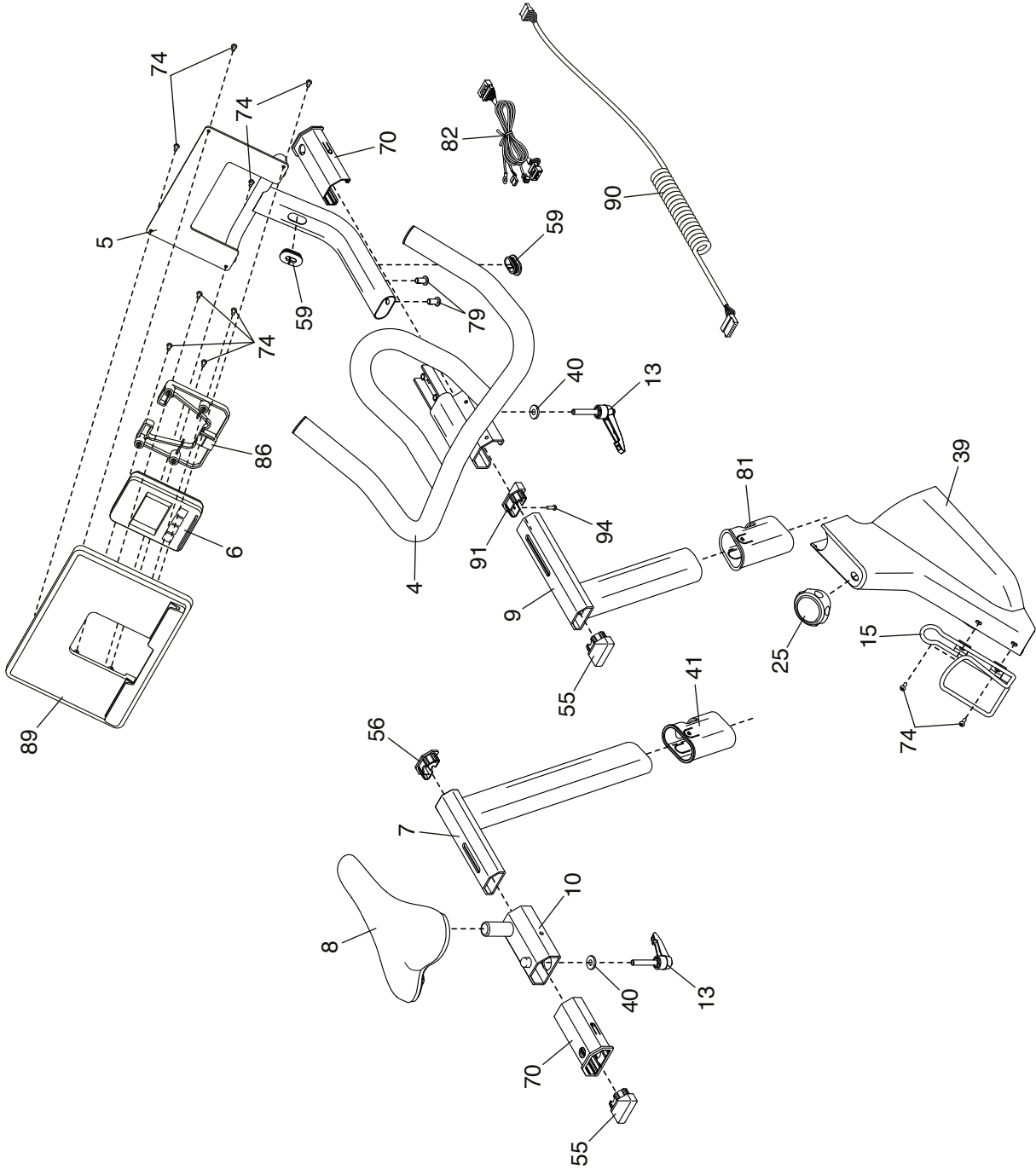

# EXPLODED DRAWING B

Model No. PFEX30124.3 R1123A

