

EXPLODED DRAWING A—Model No. PFEX3844.1

R0206A

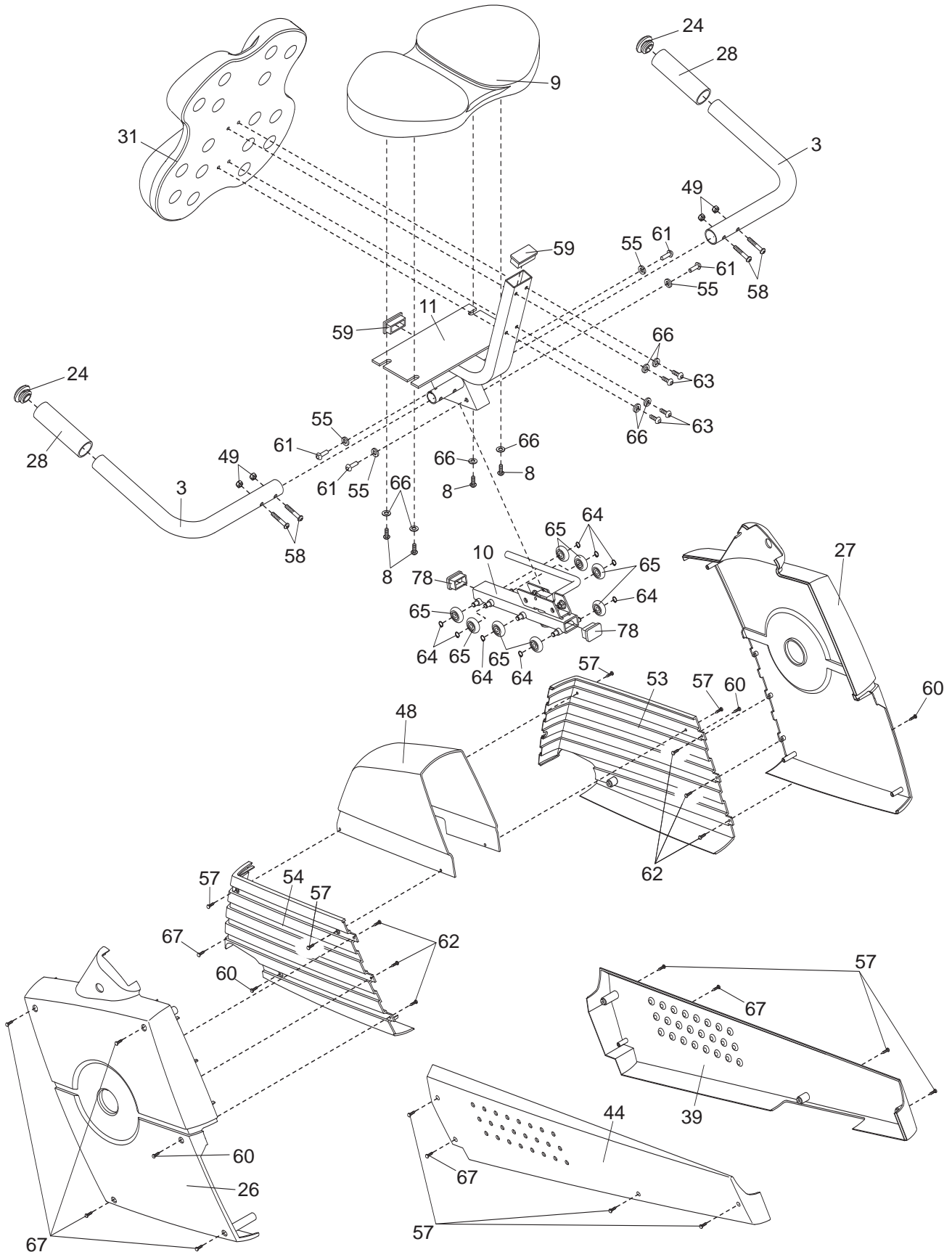

EXPLODED DRAWING B—Model No. PFEX3844.1

R0206A

