

# EXPLODED DRAWING A—Model No. PFEX44277.0

R1206A

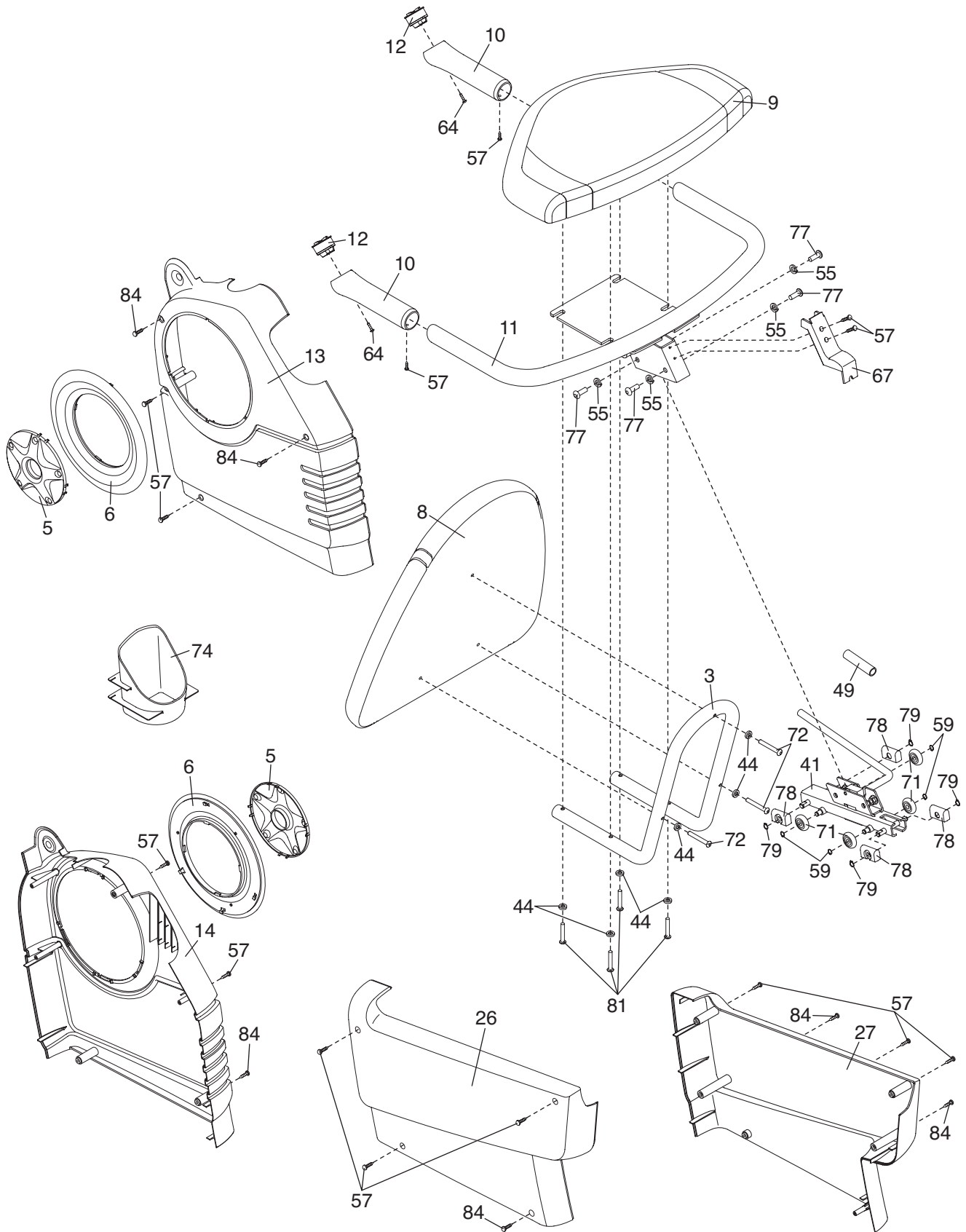

# EXPLODED DRAWING B—Model No. PFEX44277.0

R1206A

