

EXPLODED DRAWING A

Model No. PFEX52712.2 R1213A

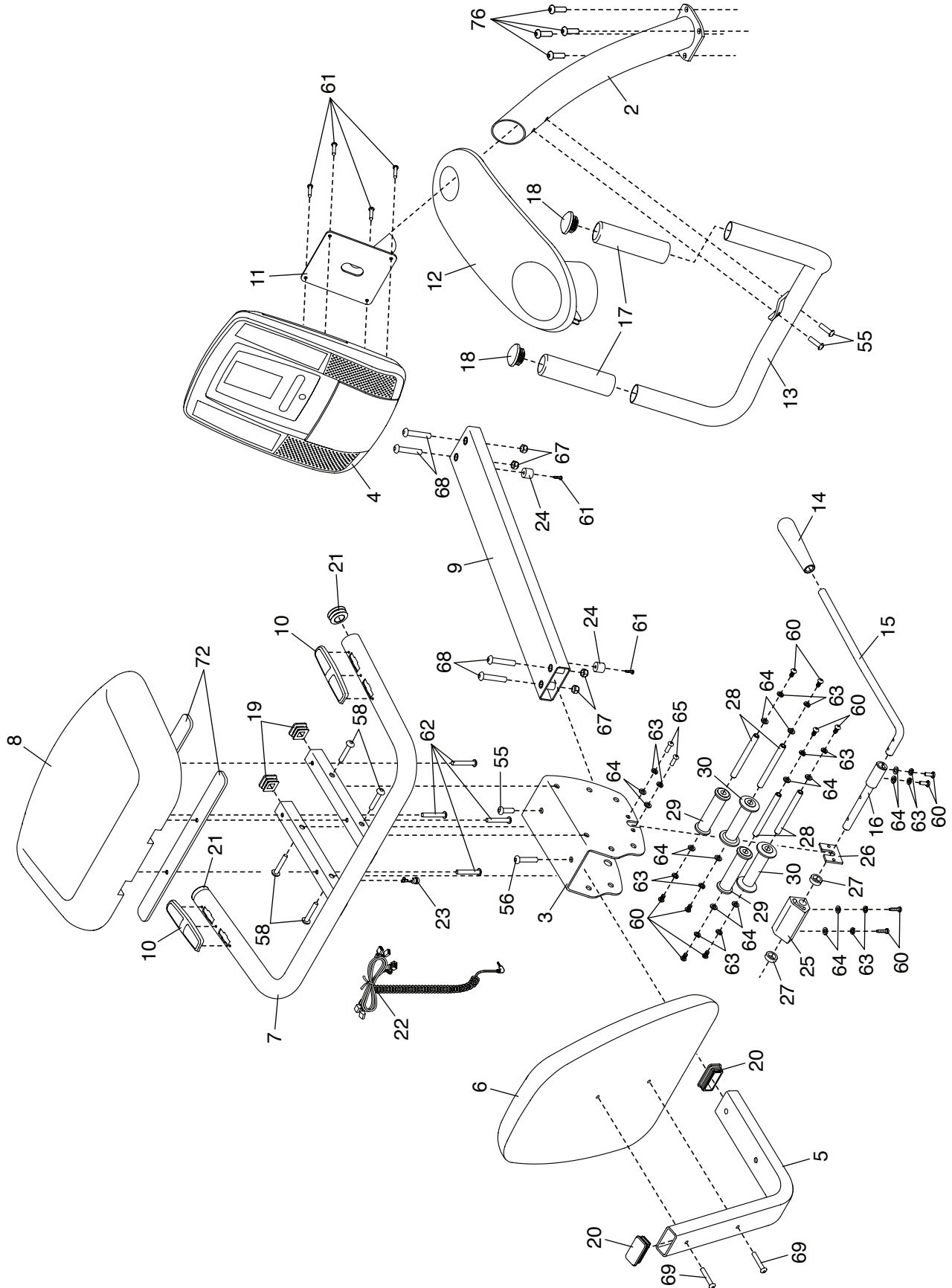

EXPLODED DRAWING B

Model No. PFE52712.2 R1213A

