

# EXPLODED DRAWING A—Model No. PFEX63910.0

R0710A

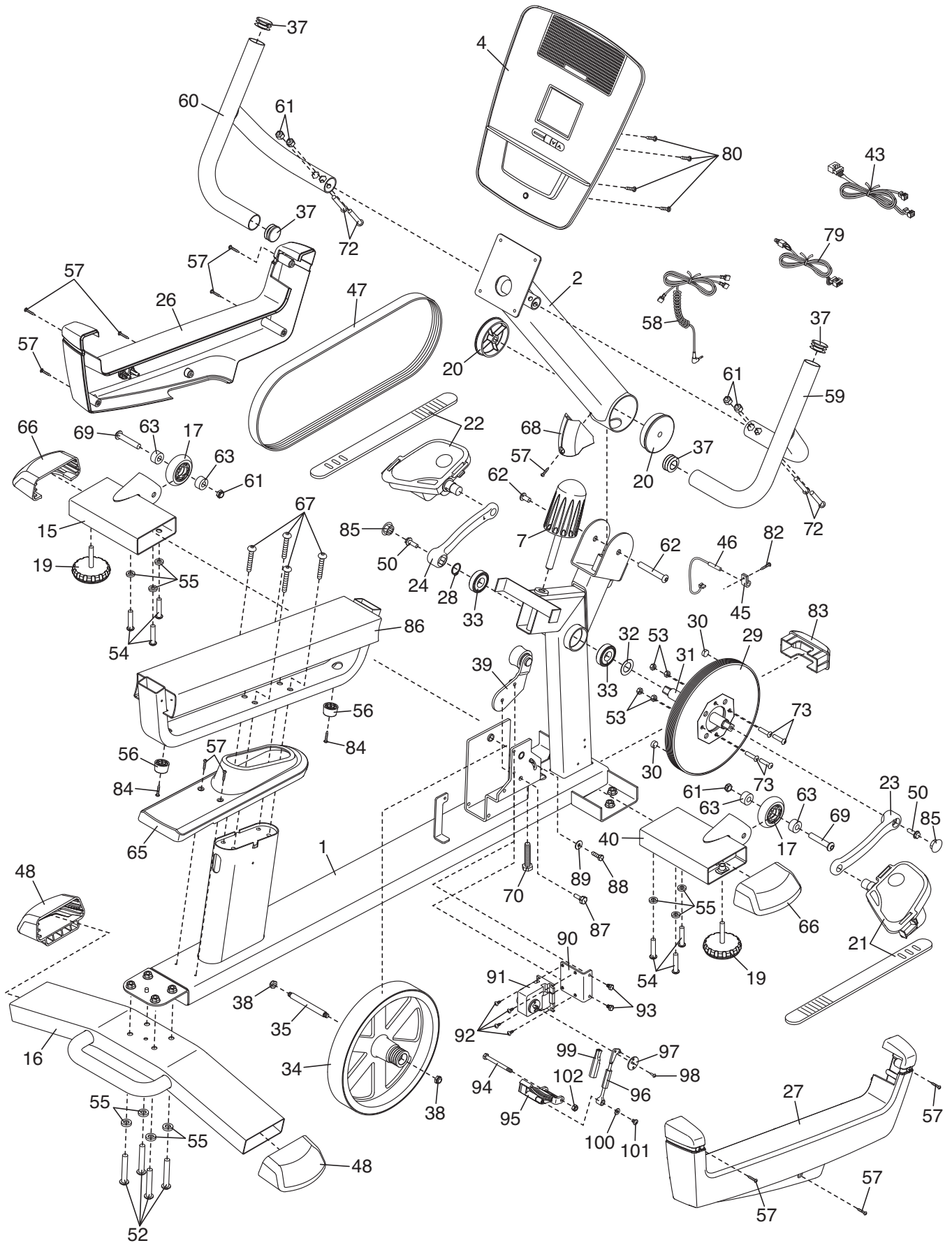

# EXPLODED DRAWING B—Model No. PFEX63910.0

R0710A

