

EXPLODED DRAWING A—Model No. PFEX73908.0

R1108A

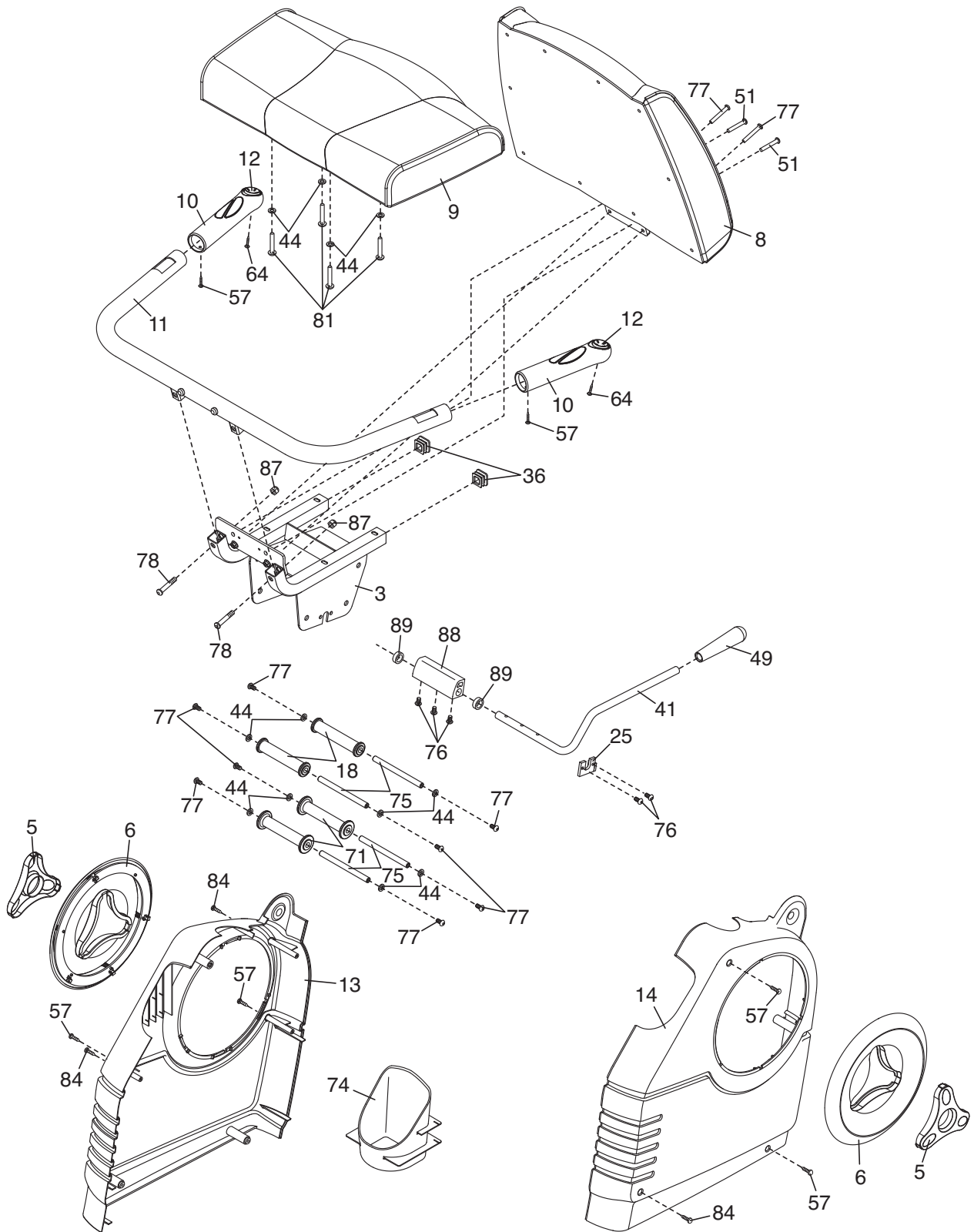

EXPLODED DRAWING B—Model No. PFEX73908.0

R1108A

