

EXPLODED DRAWING A—Model No. PFEX73908.1

R1209A

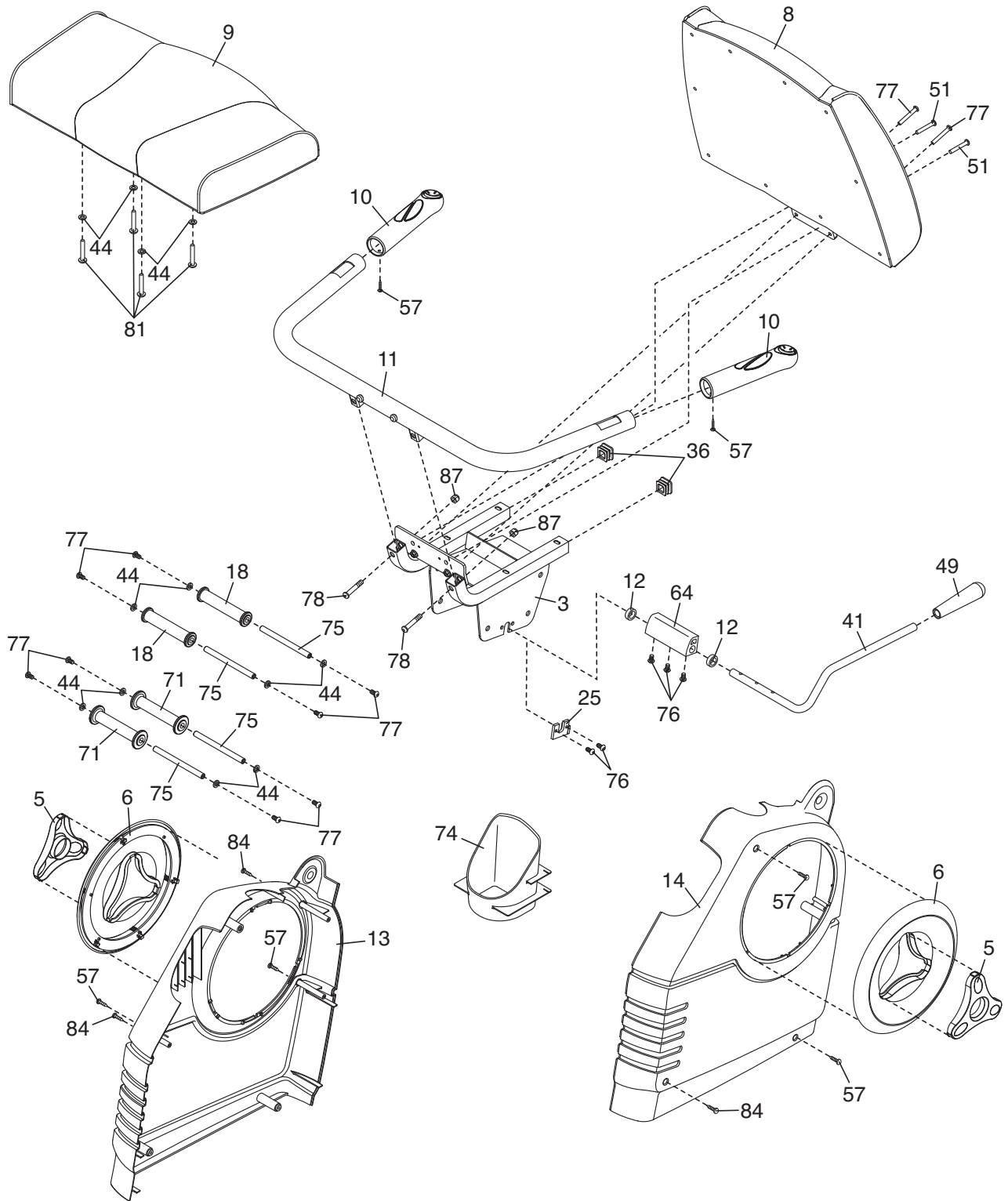

EXPLODED DRAWING B—Model No. PFEX73908.1

R1209A

