

EXPLODED DRAWING A—Model No. PFEX74207.1

R0208A

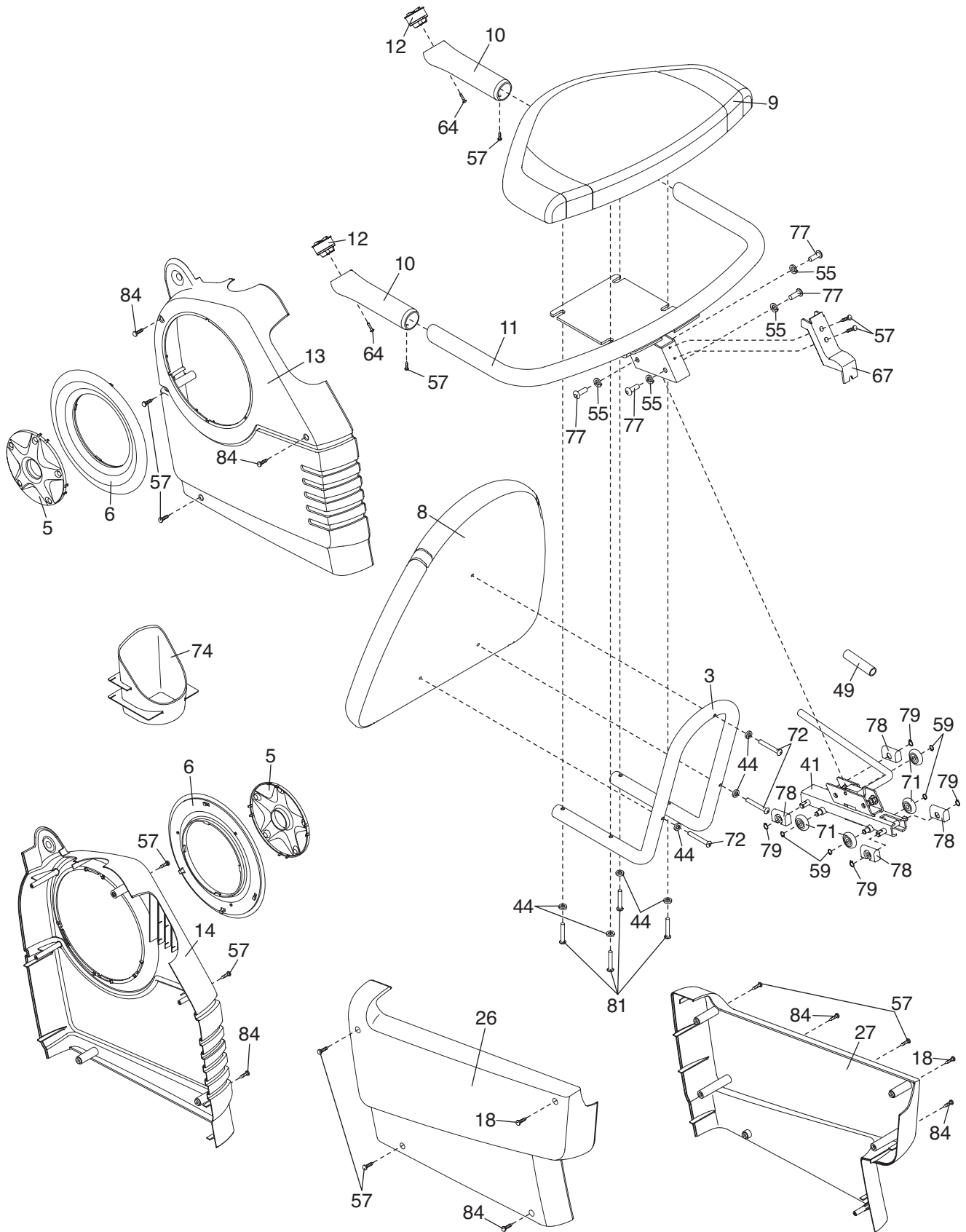

EXPLODED DRAWING B—Model No. PFX74207.1

R0208A

