

EXPLODED DRAWING A—Model No. PFEX74207.2

R0808A

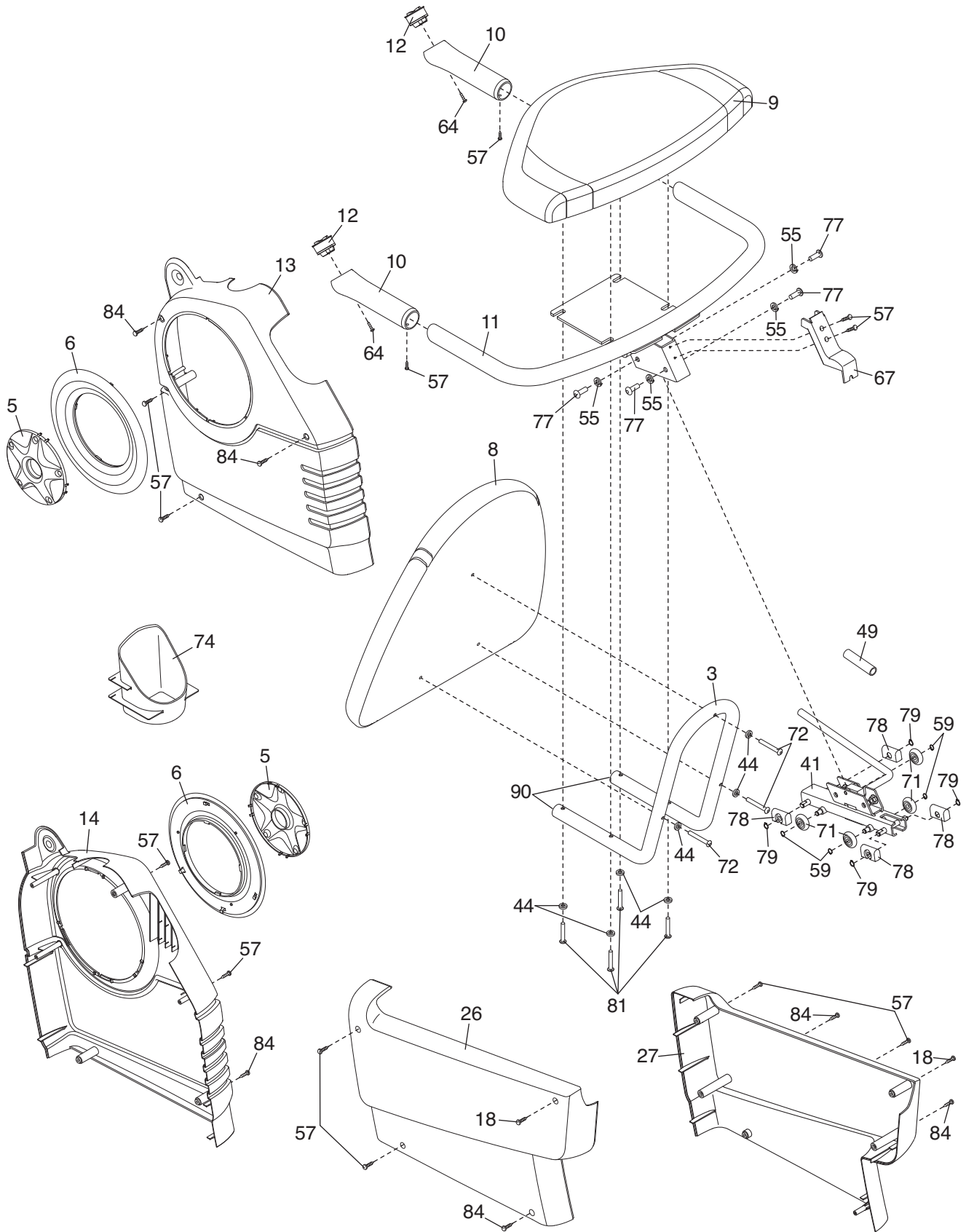

EXPLODED DRAWING B—Model No. PFX74207.2

R0808A

