

EXPLODED DRAWING A

Model No. PFEX92220.4 R1021A

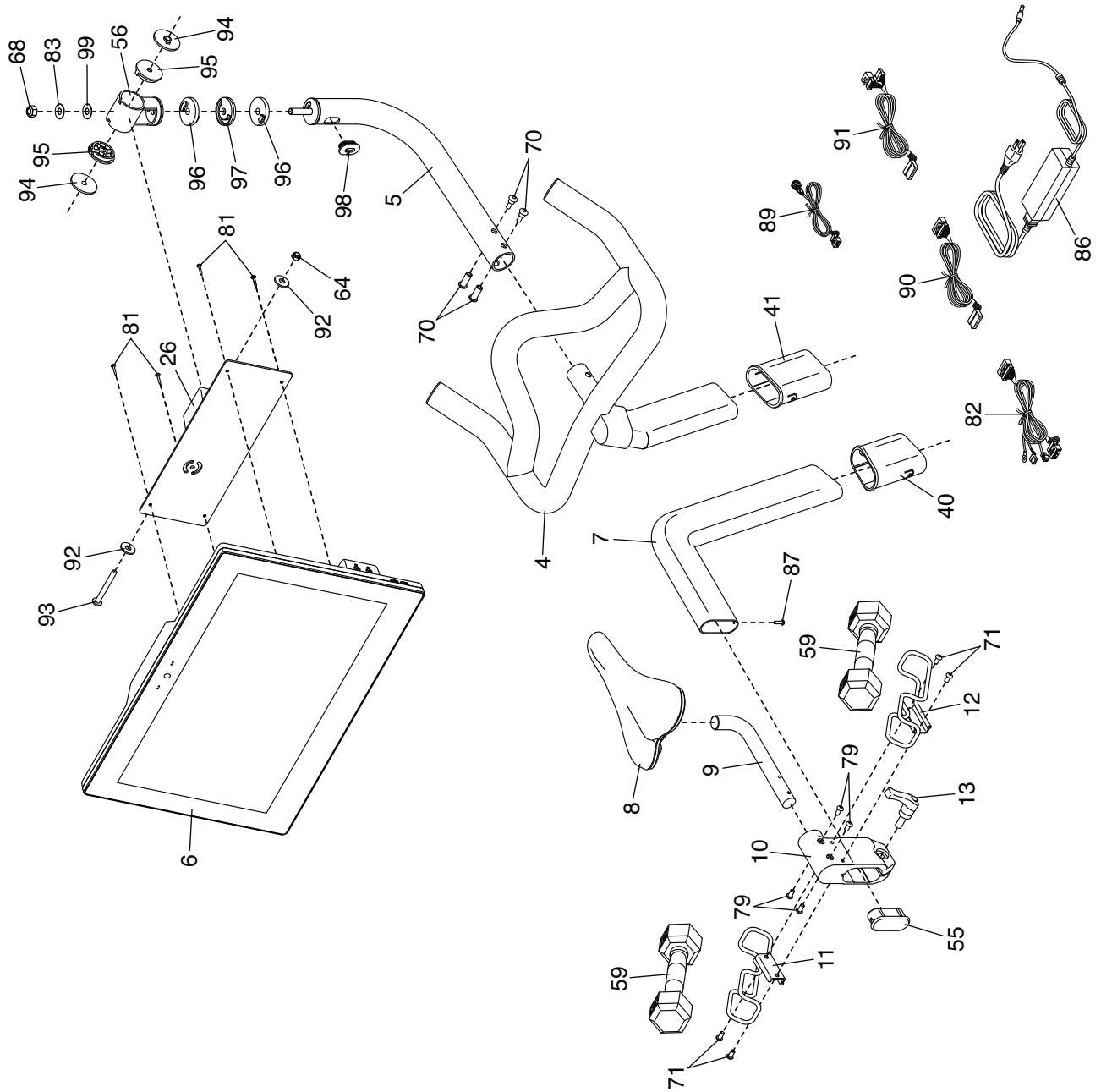

EXPLODED DRAWING B

Model No. PFE92220.4 R1021A

