

EXPLODED DRAWING A—Model No. PFTL01099.1

R0410A

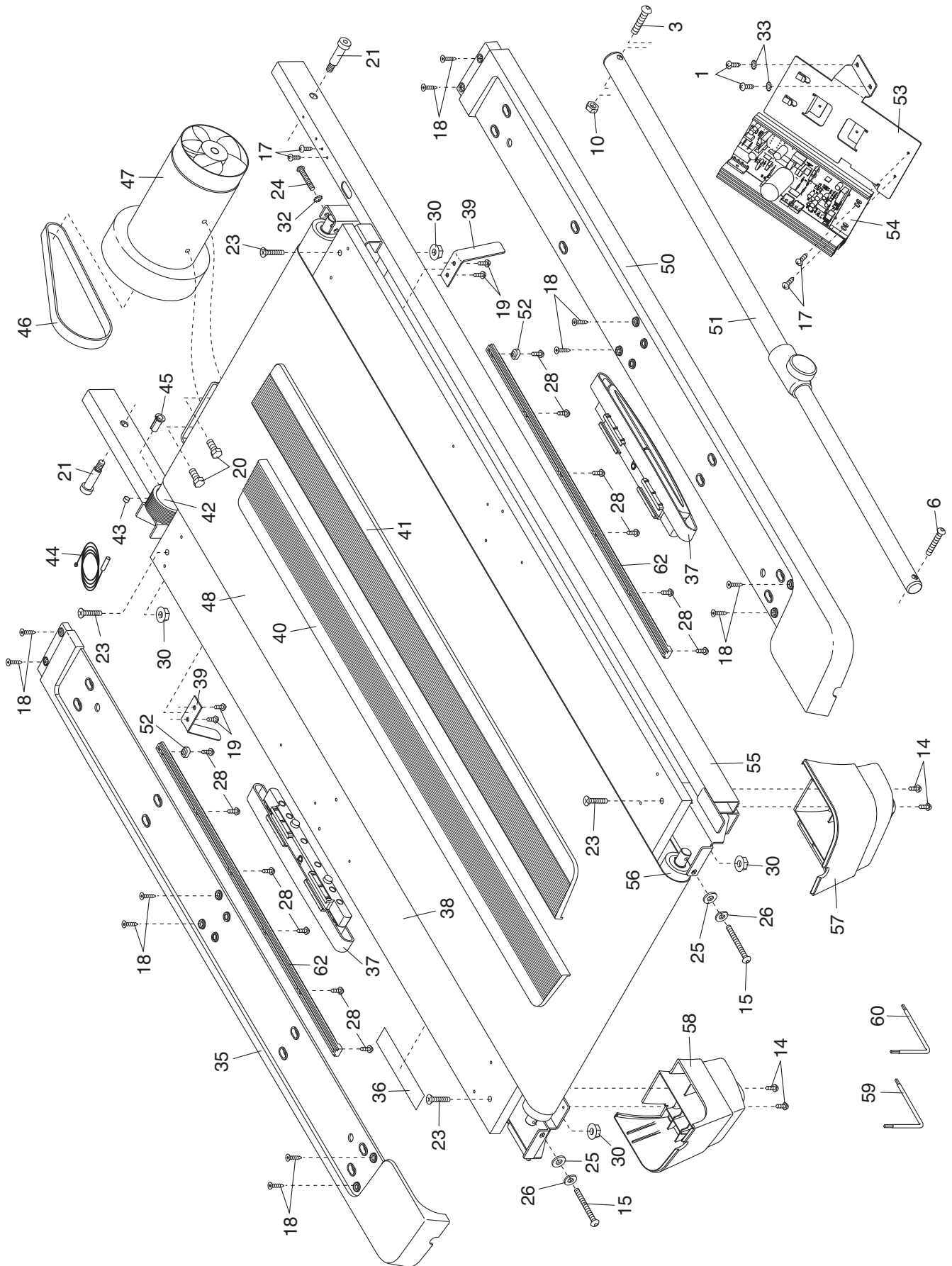

EXPLODED DRAWING B—Model No. PFTL01099.1

R0410A

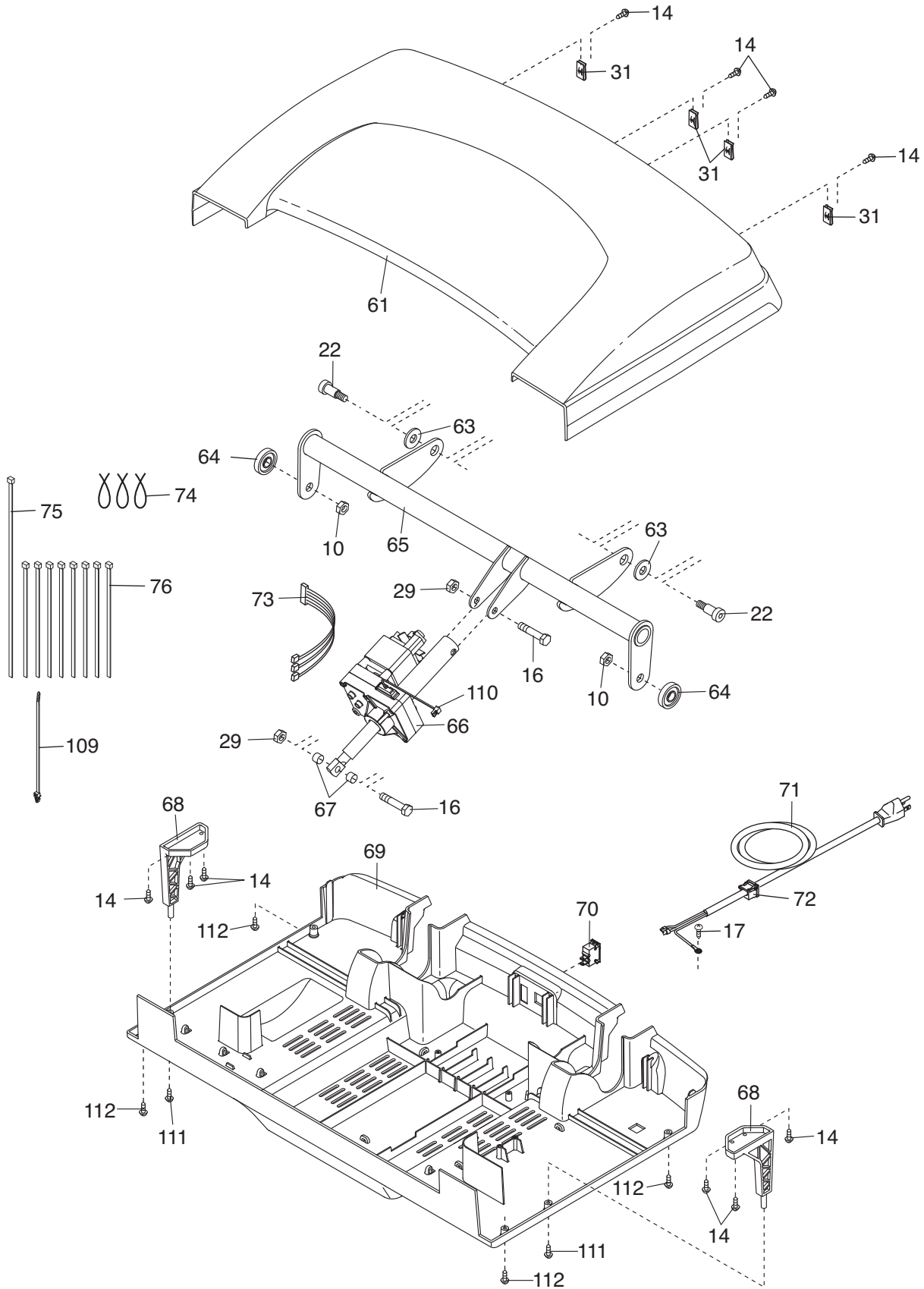

EXPLODED DRAWING C—Model No. PFTL01099.1

R0410A

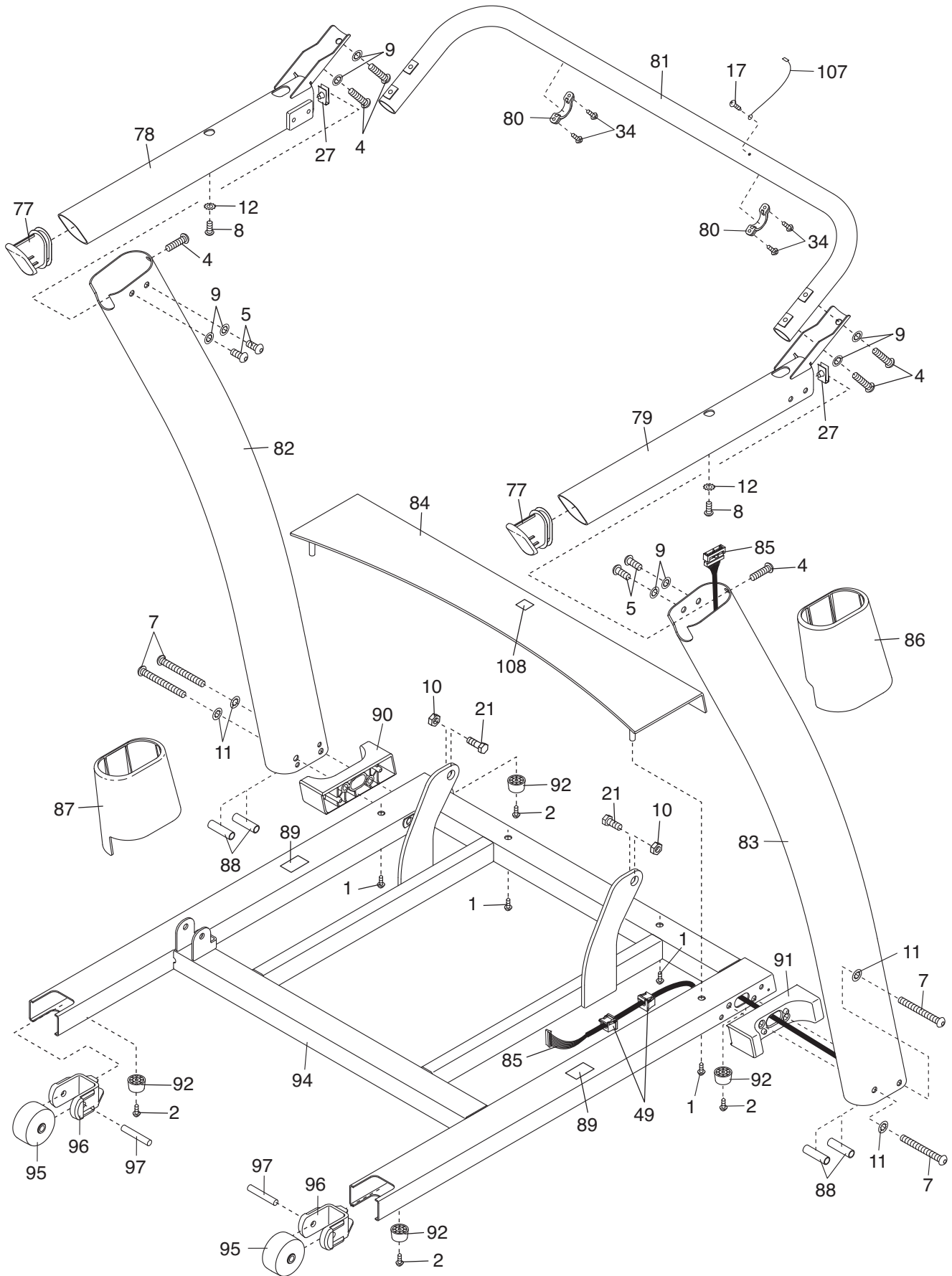

EXPLODED DRAWING D—Model No. PFTL01099.1

R0410A

