

EXPLODED DRAWING A—Model No. PFTL01299.2

R0610A

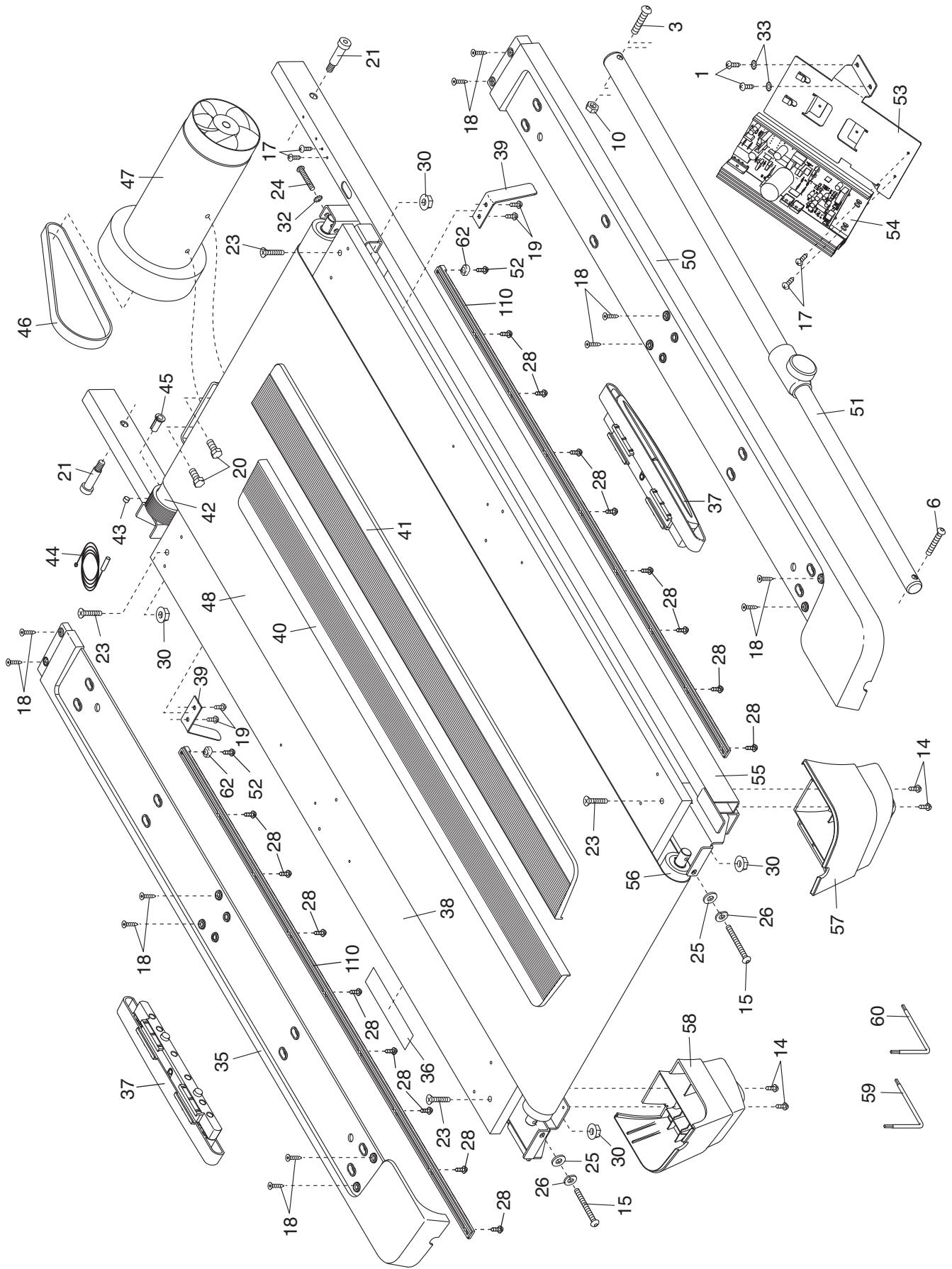

EXPLODED DRAWING B—Model No. PFTL01299.2

R0610A

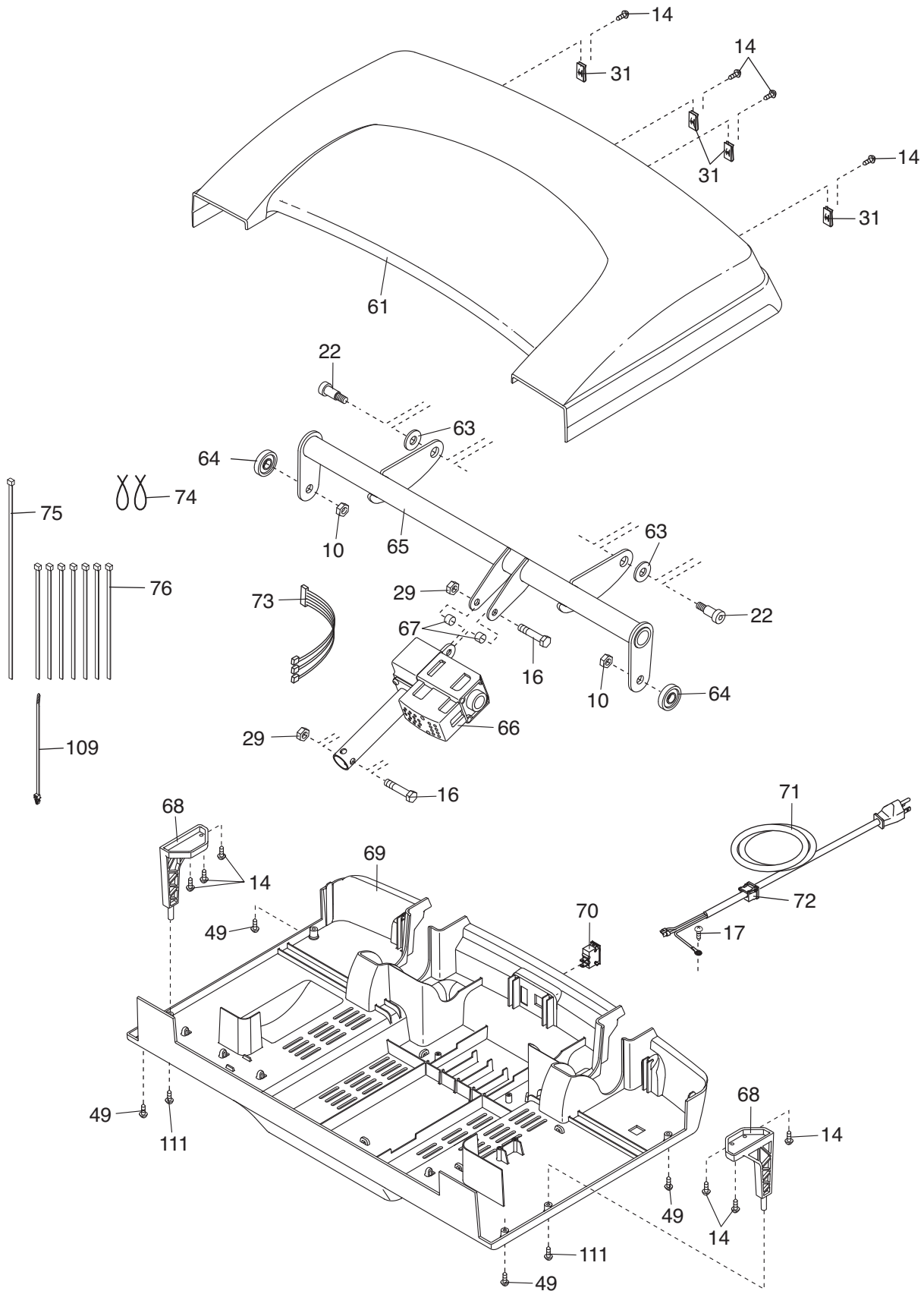

EXPLODED DRAWING C—Model No. PFTL01299.2

R0610A

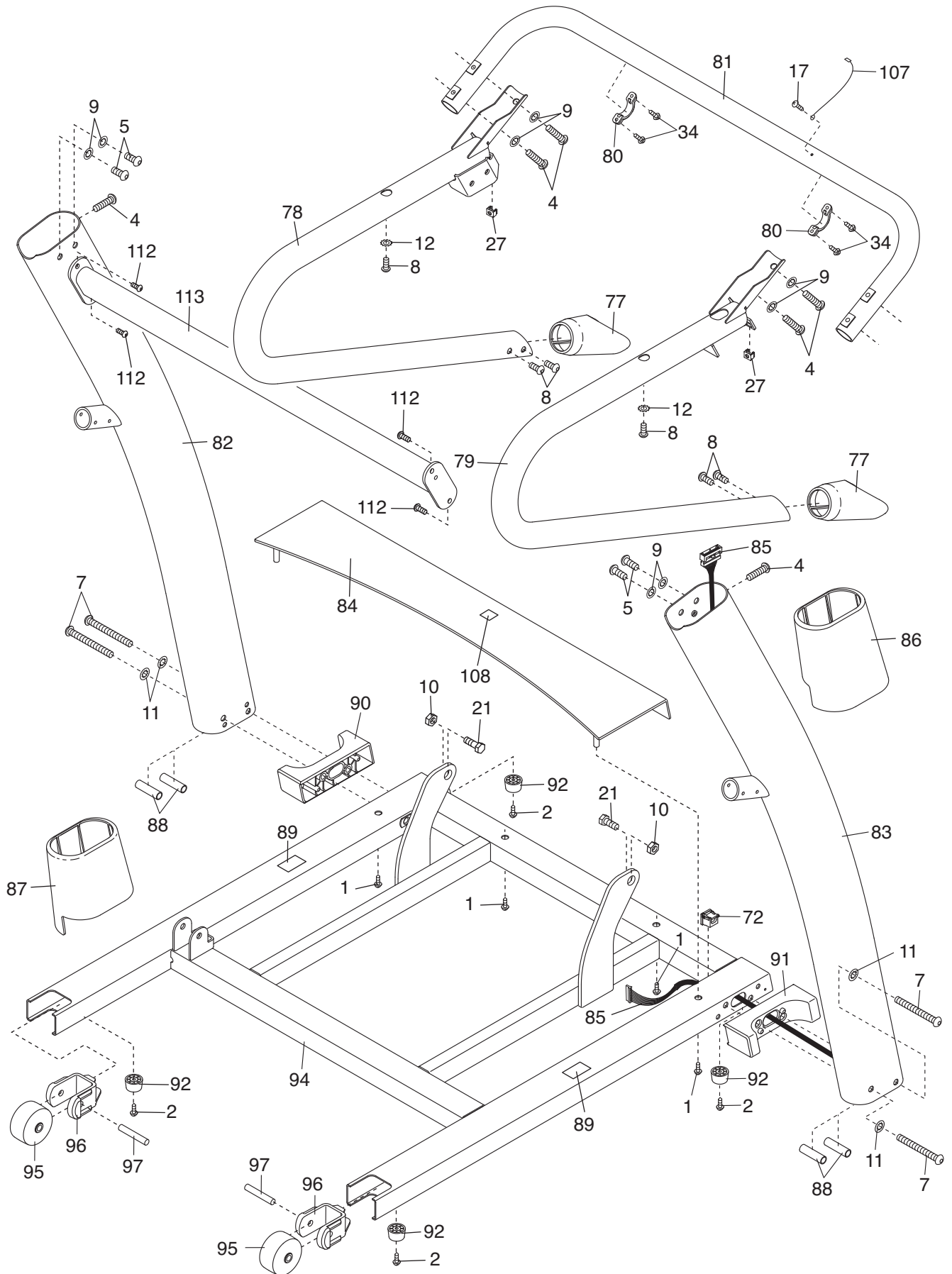

EXPLODED DRAWING D—Model No. PFTL01299.2

R0610A

