

# EXPLODED DRAWING A—Model No. PFTL01299.1

R0410A

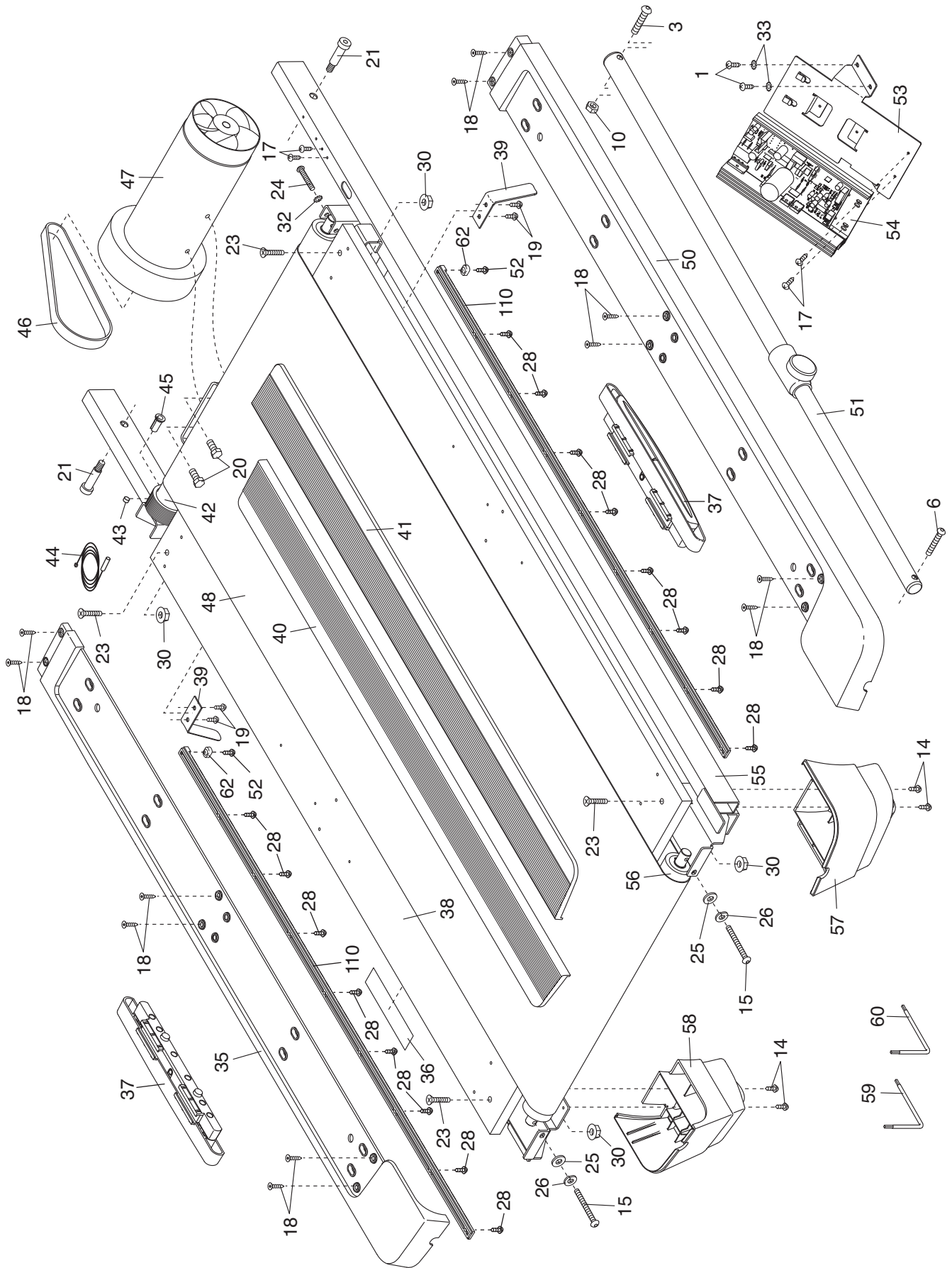

# EXPLODED DRAWING B—Model No. PFTL01299.1

R0410A

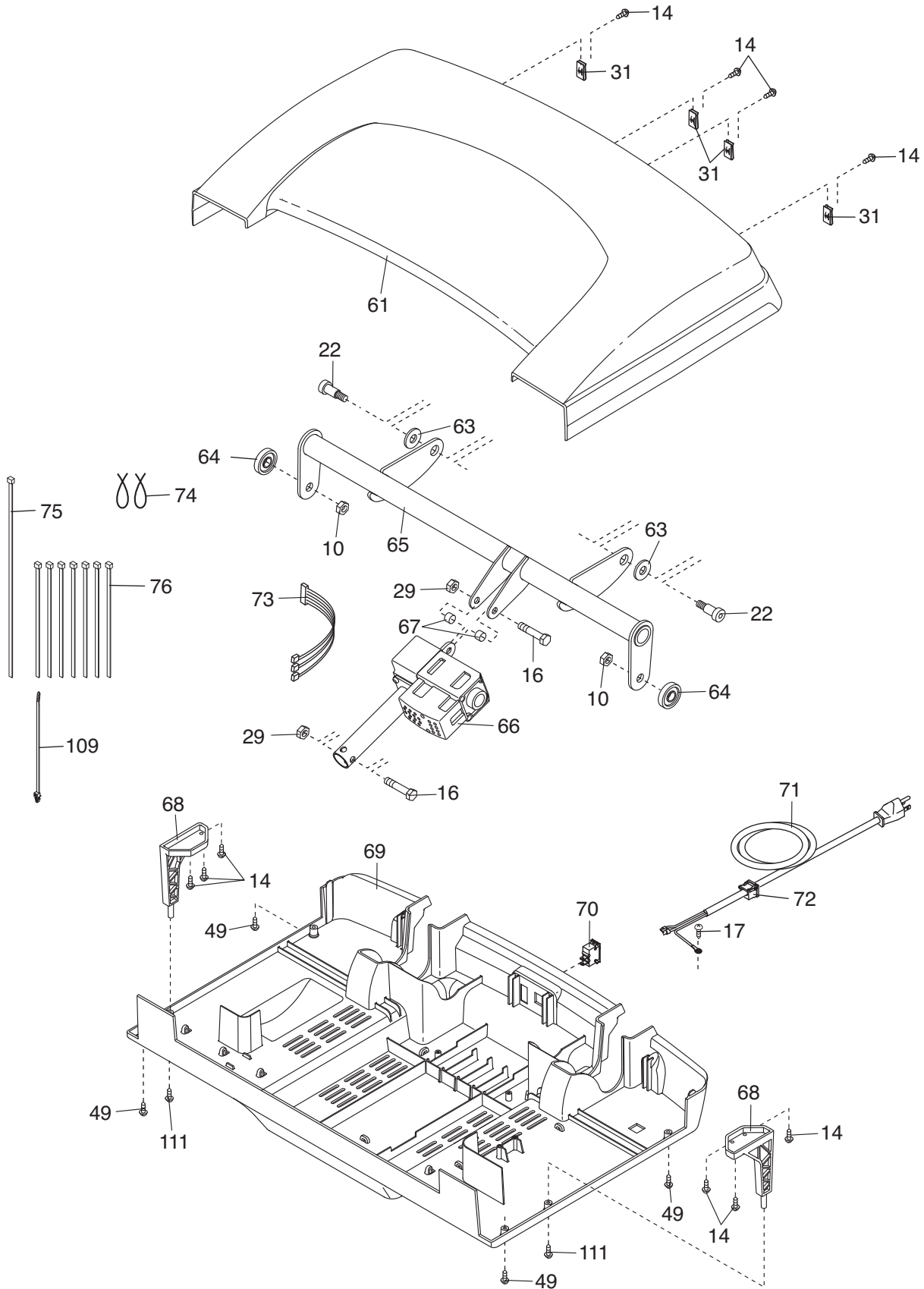

# EXPLODED DRAWING C—Model No. PFTL01299.1

R0410A

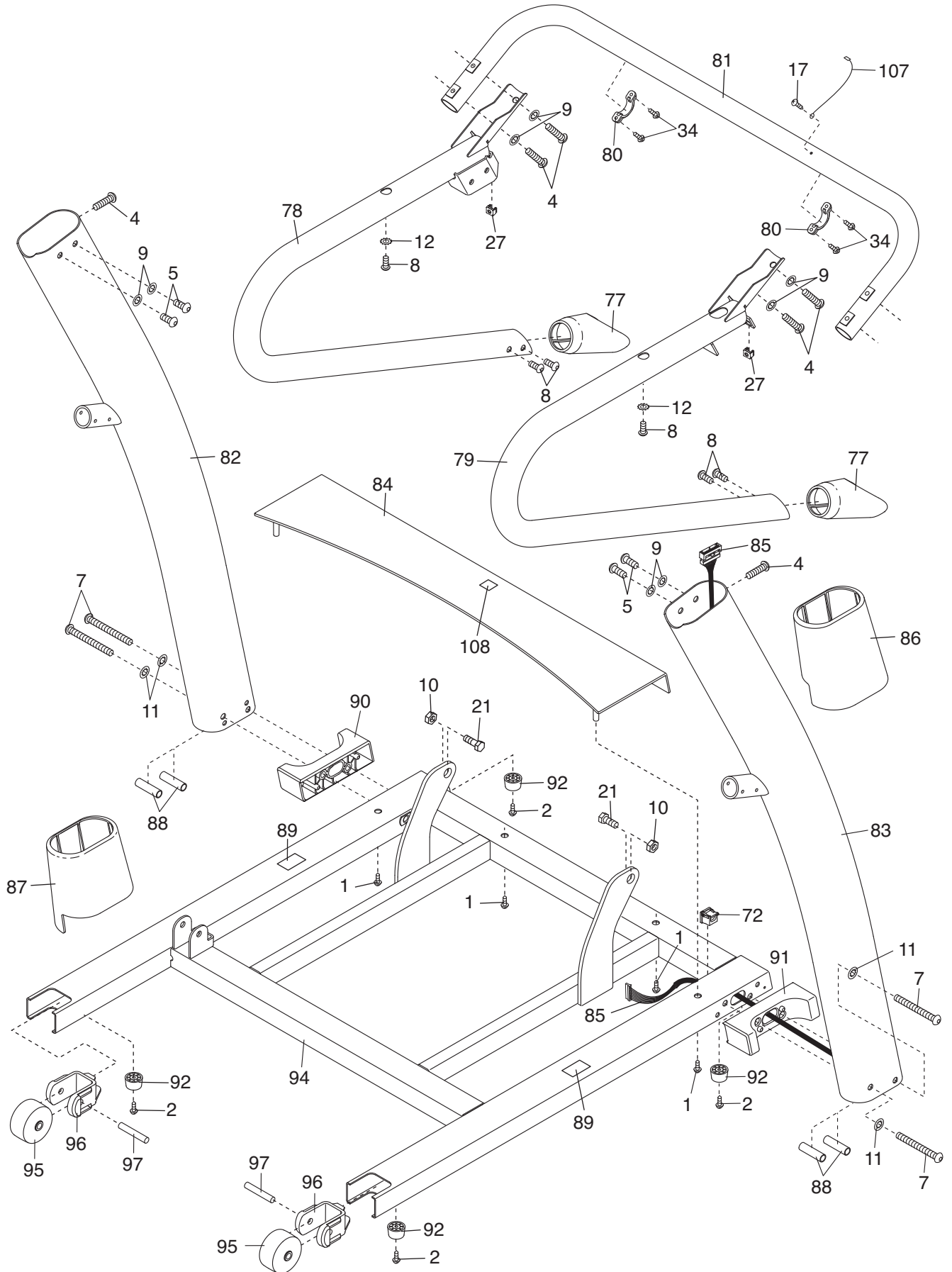

# EXPLODED DRAWING D—Model No. PFTL01299.1

R0410A

