

EXPLODED DRAWING A

Model No. PFTL01411.0 R0911A

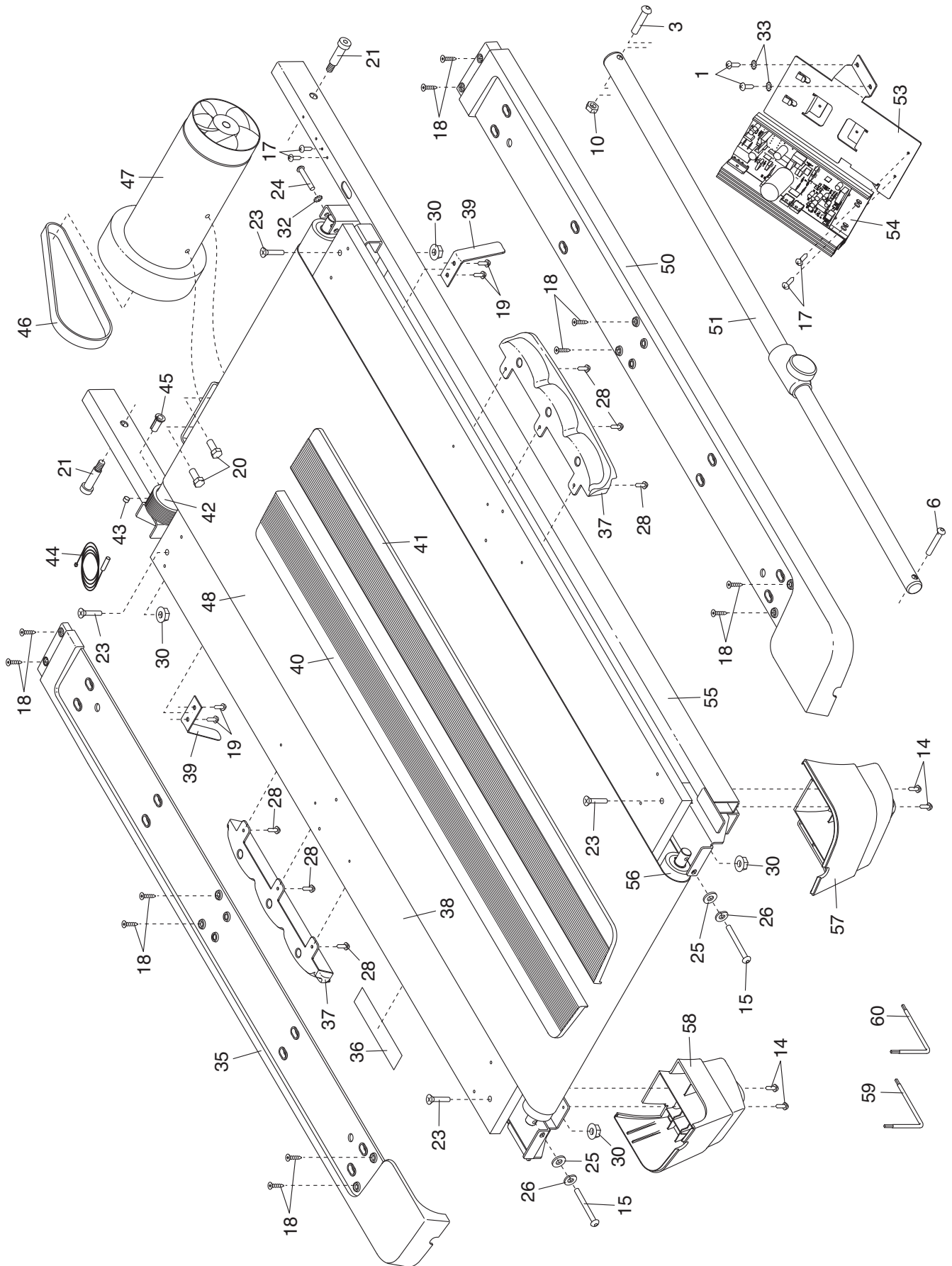

EXPLODED DRAWING B

Model No. PFTL01411.0 R0911A

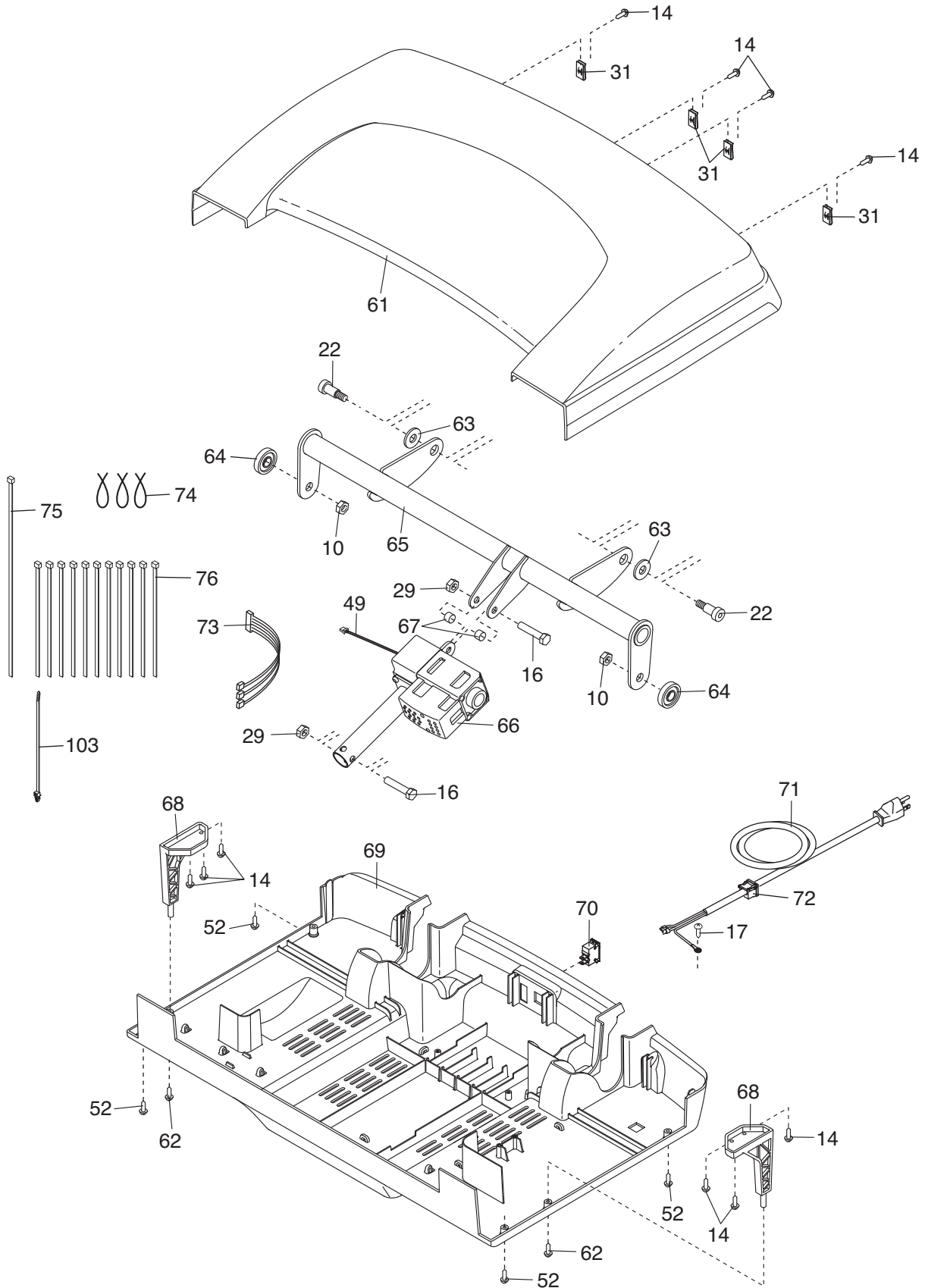

EXPLODED DRAWING C

Model No. PFTL01411.0 R0911A

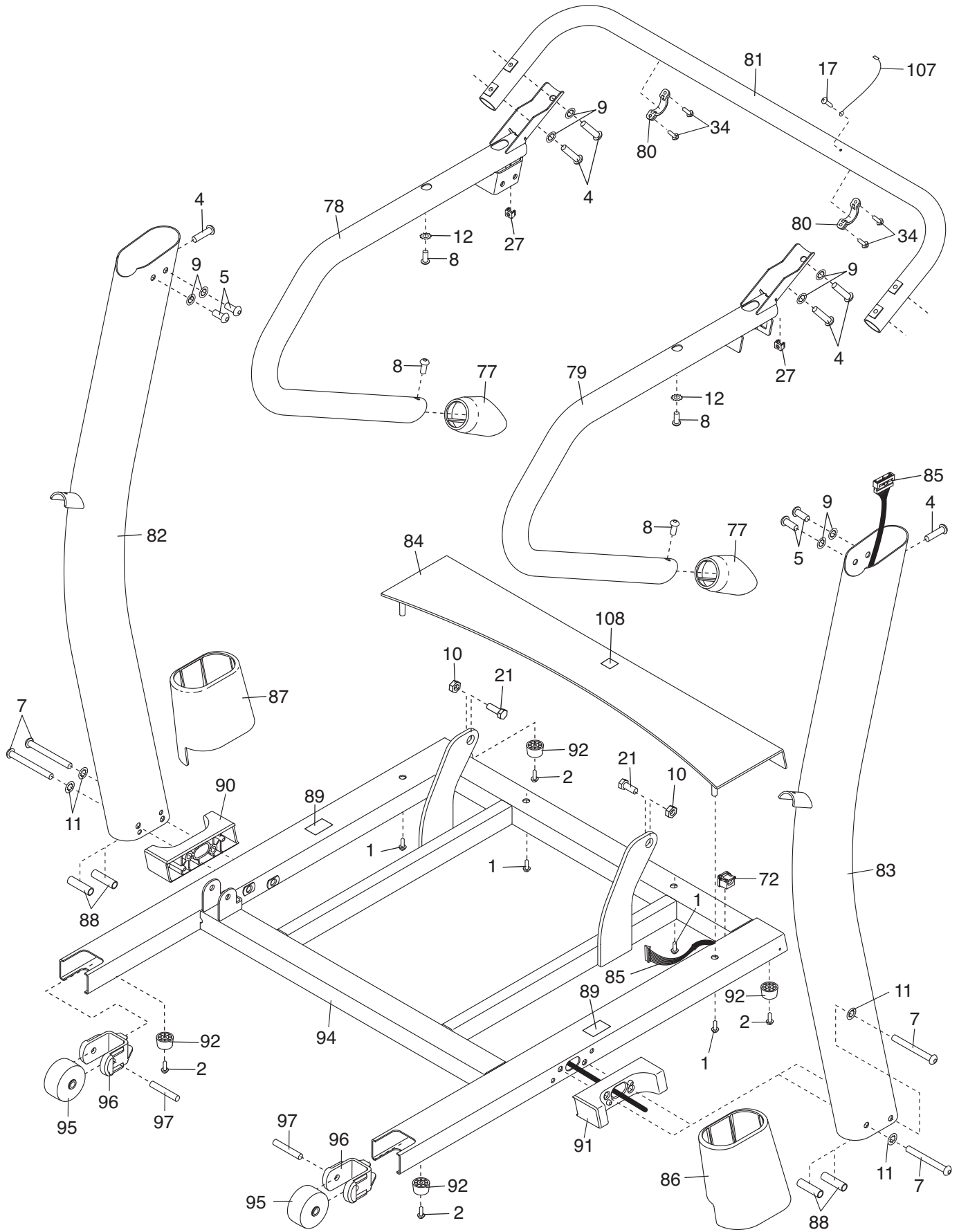

EXPLODED DRAWING D

Model No. PFTL01411.0 R0911A

