

EXPLODED DRAWING—Model No. PFTL09910

R0202A

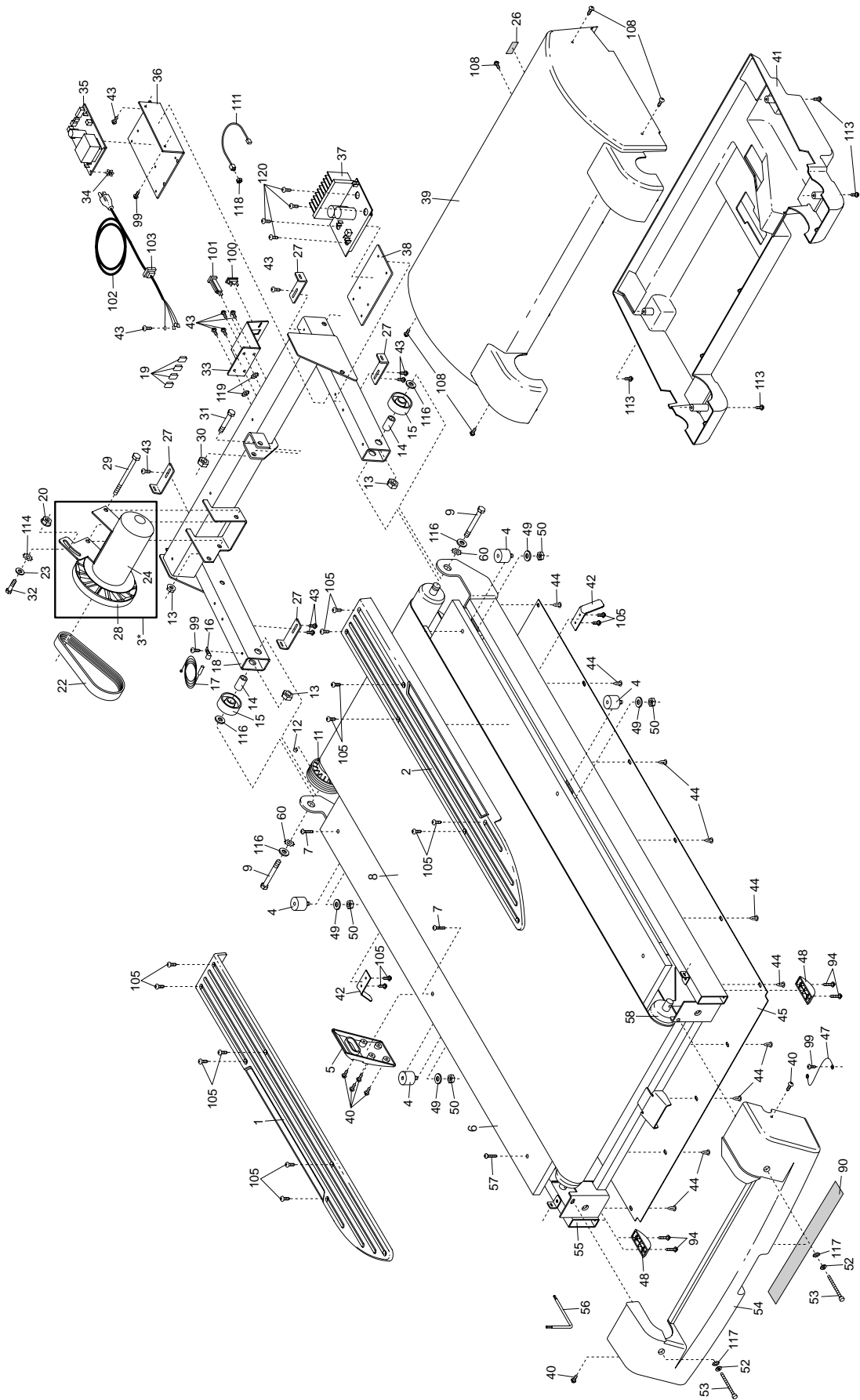

EXPLODED DRAWING—Model No. PFTL09910

R0202A

